



**Notice of a public meeting of
Children, Education & Communities Policy & Scrutiny Committee**

- To:** Councillors Taylor (Chair), Fenton (Vice-Chair),
S Barnes, Brooks, Crawshaw, Dew and Jackson

Mr Hagon (Co-opted Statutory Member)
- Date:** Wednesday, 10 January 2018
- Time:** 5.30 pm
- Venue:** The Thornton Room - Ground Floor, West Offices (G039)

AGENDA

1. Declarations of Interest

At this point, Members are asked to declare:

- any personal interests not included on the Register of Interests
- any prejudicial interests or
- any disclosable pecuniary interests

which they may have in respect of business on this agenda

2. Minutes

(Pages 1 - 8)

To approve and sign the minutes of the meeting held on 14 November 2017.

3. Public Participation

At this point in the meeting members of the public who have registered to speak can do so. The deadline for registering is **5.00pm on Tuesday, 9 January 2018**. Members of the public can speak on agenda items or matters within the remit of the committee.

To register to speak please contact the Democracy Officers for the meeting, on the details at the foot of the agenda.

Filming, Recording or Webcasting Meetings

Please note that, subject to available resources, this meeting will be filmed and webcast, or recorded, including any registered public speakers who have given their permission. The broadcast can be viewed at <http://www.york.gov.uk/webcasts> or, if sound recorded, this will be uploaded onto the Council's website following the meeting.

Residents are welcome to photograph, film or record Councillors and Officers at all meetings open to the press and public. This includes the use of social media reporting, i.e. tweeting. Anyone wishing to film, record or take photos at any public meeting should contact the Democracy Officers (whose contact details are at the foot of this agenda) in advance of the meeting.

The Council's protocol on Webcasting, Filming & Recording of Meetings ensures that these practices are carried out in a manner both respectful to the conduct of the meeting and all those present. It can be viewed at http://www.york.gov.uk/download/downloads/id/11406/protocol_for_webcasting_filming_and_recording_of_council_meetings_20160809.pdf

- 4. York Museums Trust Report Against Core Objectives - July to December 2017** (Pages 9 - 18)

This report from the York Museums Trust provides the latest bi-annual update on the Trust's progress against the agreed core partnership objectives.
- 5. 2017/18 Finance and Performance Second Quarter Monitoring Report - Children, Education & Communities** (Pages 19 - 30)

This report provides an update on the latest financial and performance position with regard to the plans and budgets for services falling under the responsibility of the Corporate Director of Children, Education & Communities.
- 6. WW1 Commemorations Scrutiny Review Draft Final Report** (Pages 31 - 120)

This report presents the findings of the Scrutiny Review into the city's plans for commemorating the centenary of the end of World War One and asks Members to consider and endorse the Task Group's draft recommendations.

7. Work Plan 2017/18 (Pages 121 - 122)

Members are asked to consider the Committee's work plan for the 2017-18 municipal year.

8. Urgent Business

Any other business which the Chair considers urgent under the Local Government Act 1972.

Democracy Officers

Catherine Clarke and Louise Cook (job share)

Contact details:

- Telephone – (01904) 551031
- Email catherine.clarke@york.gov.uk and louise.cook@york.gov.uk

(If contacting by email, please send to both Democracy Officers named above).

For more information about any of the following please contact the Democratic Services Officer responsible for servicing this meeting:

- Registering to speak
- Business of the meeting
- Any special arrangements
- Copies of reports and
- For receiving reports in other formats

Contact details are set out above.

This information can be provided in your own language.

我們也用您們的語言提供這個信息 (Cantonese)

এই তথ্য আপনার নিজের ভাষায় দেয়া যেতে পারে। (Bengali)

Ta informacja może być dostarczona w twoim własnym języku. (Polish)

Bu bilgiyi kendi dilinizde almanız mümkündür. (Turkish)

یہ معلومات آپ کی اپنی زبان (بولی) میں بھی مہیا کی جاسکتی ہیں۔ (Urdu)

 (01904) 551550

This page is intentionally left blank

City of York Council

Committee Minutes

Meeting	Children, Education & Communities Policy & Scrutiny Committee
Date	14 November 2017
Present	Councillors Taylor (Chair), Fenton (Vice-Chair), S Barnes, Brooks, Crawshaw, Dew and Jackson
Apologies	Mr Hagon

19. Declarations of Interest

Members were asked to declare, at this point in the meeting, any personal interests, not included on the Register of Interests, or any prejudicial or disclosable pecuniary interests they may have in respect of business on the agenda.

Cllr S Barnes disclosed a personal non-prejudicial interest in agenda item 7 (School Improvement Update) and agenda item 8 (Academisation, School Organisation and Place Planning Summary), due to his daughter attending Robert Wilkinson Primary School.

Cllr Taylor disclosed a personal non-prejudicial interest in agenda item 4 (Scrutiny Report – Explore York Libraries and Archives) due to his involvement in the promotion of Big City Read through his employment at City Screen.

Cllr Brooks disclosed a personal non-prejudicial interest in that she is a governor on the Leeds and York Mental Health Trust.

20. Minutes

Resolved: That the minutes of the meeting of the Committee held on 19 September 2017 be approved as a correct record and then signed by the Chair.

21. Public Participation

It was reported that there had been no registrations to speak at the meeting under the Council's Public Participation Scheme.

22. Scrutiny Report - Explore York Libraries and Archives

Committee Members considered a report that updated them on the performance of Explore York Libraries and Archives Mutual Ltd (Explore).

Members noted that the Chief Executive of York Explore had sent her apologies and the Scrutiny Officer offered to feed any questions back to her.

Some Members commented on the results of the staff wellbeing survey and the committee welcomed the encouraging results around staff feeling their job was worthwhile.

The Chair stated that the consultation on the future of library services had begun and would run until 14 February 2018. Members noted that the consultation could be viewed at www.york.gov.uk/consultations and staff working at York Explore would be available to assist anyone who may need help completing it online.

Resolved: That the report be noted.

Reason: To help monitor the service received under the contract.

23. Make It York Scrutiny Update

Members considered a report that updated them on the progress of Make It York (MIY) with regard to the Service Level Agreement with City of York Council.

The Managing Director of MIY was in attendance to present the report and he highlighted some of the events and festivals that had taken place over 2017, which had contributed to a rise in visitor numbers, resulting in a positive outlook for York's tourism. He stated that Visit York were re-launching their website and that the purchase of the York Pass was 62% up on last years figures.

The proposed 2018 events and festivals were discussed and Members noted York's offer would include a new 4 day horticultural festival called Bloom which would tie in with the 250th anniversary of the Ancient Society of York Florists.

The Managing Director highlighted the cultural events taking place, which included the 2nd Culture Awards and it was noted that the progress made on developing a cultural strategy for the city was taking longer than anticipated.

Members were informed that MIY were on track to achieve their full year budget, which was helped by the renaissance of the Shambles Market and the growing success of the food court.

In answer to Members questions it was noted that:

- The early evening offer within the city centre had uplifted due to the vast selection of restaurants and bars but that it was still proving difficult to persuade shops to stay open late one night a week.
- Organisers of the Balloon Festival were considering the comments received and were working on repairing any damaged caused by the adverse weather.
- The Shambles Market currently had a temporary cover and that a permanent cover was being considered to maintain momentum during the winter months and to allow the area to be used for performances during the day and evening.
- Better signage to the Shambles Market was required and the approach from Silver Street needed to be made more attractive.
- MIY were in the process of raising funding to promote Bloom and to date had received a positive response from many organisations who would like to provide content for the festival, which if successful, could become a potential annual event.

Following discussions around engaging more young people in the development of the cultural offer, Members thanked the Managing Director for his report and were encouraged to hear what was on offer during 2018.

Resolved: That the update be noted.

Reason: To fulfil the Council's role under the agreed partnership arrangements.

24. Update on Implementation of Local Area Teams

Members considered a report that provided them with an update on Local Area Teams.

The Corporate Director of Children, Education and Communities introduced the report and stated that the development of Local Area Teams had been a significant piece of work that was not just a set of council services but a multi agency approach that brought together all partners in a local area that existed in the lives of children, young people and families.

The new set of arrangements were launched in January 2017 and the Head of Early Help and Local Area Teams continued to explain the progress made since Members were last updated in March 2017 and it was noted that:

- The transition plan ran until March 2018.
- Local Area Teams now included the Healthy Child Service where progress had already been achieved through the integration.
- Engagement with all elected Members had taken place and briefing sessions had been provided.
- Childcare funding for two year olds had increased to 76%.
- The young people's service was now established at 30 Clarence Street and the transition had gone well, the offer would be developed through the creation of a new partnership.

Officers responded to Members questions where it was acknowledged that:

- Volunteers were recruited by publicising the schemes through press releases and social media and then appointed following appropriate checks and training.
- Officers had received feedback from young people and were currently considering ways to promote 30 Clarence Street to engage more young people in the development of the offer.
- There was a system in place to ensure all queries received were logged and then pursued, should the enquiry require further support.
- Officers were developing a reporting system that would reflect the work of Local Area Teams.

- Officers had developed good relationships with all the multi agency's, which had already helped bring communities together.
- Two school nurses had been recruited and the number of health outreach nurses had also increased.
- Complaints on anti social behaviour would be considered by all the relevant partners, who would work together to develop a solution.

Members thanked officers and everyone involved in the development of LAT's and it was recognised that the implementation had been a considerable piece of work.

Resolved: That the report be noted.

Reason: To keep Members updated on the implementation of Local Area Teams.

25. School Improvement Update

Members considered a report that provided information about school performance in the academic year 2016/17, and about the positions of schools according to Ofsted inspection judgements as of 1 November 2017.

The Assistant Director of Education and Skills was in attendance to present the report and she highlighted the primary and secondary school performance results from Early Years Foundation Stage through to Key Stage 5. She confirmed that across all Key Stages the city continued to perform well against national benchmarks and that the early years foundation stage had maintained their good level of development, which gave children a more secure journey through the Key Stages.

Members were informed that:

- Primary outcomes had progressed and the work undertaken to improve writing had been successful resulting in a significant uplift in writing outcomes in both Key Stages. This success had lead to a partnership funding bid win of £196,000 to extend work in writing.
- A new KS4 numerical national performance grading system was now used in English and mathematics where grade 4 was a standard pass and grade 5 a good pass.

All other subjects would continue to be graded using the A*-G grading system until a phased roll out had been completed.

- The gaps had narrowed throughout KS1 to KS4
- Outcomes in KS5 continued to be strong with all school sixth forms performing strongly against value added benchmarks.
- Ofsted Judgements continued to improve and specialist provision was 100% better.
- Schools continued to work together to ensure the correct interventions were in place to improve performance results.
- School sixth forms were working more closely together to ensure a more sustainable offer to enable a more balanced and broad curriculum.

Members noted that the performance in the new reformed GCSEs was very strong and the percentage of pupils achieving grade 5 and above in English and mathematics was above national average. Members also noted that the new results were not directly comparable to the A*-G grading due to an enhancement in the national standards and discussions took place around how schools were going to monitor and benchmark those results.

Officers responded to Members questions and in regard to narrowing the gap officers agreed to provide further information on school improvement interventions at a future committee meeting.

Members thanked officers for the report and welcomed the positive outcomes throughout the Key Stages and the encouraging results in narrowing the gaps.

Resolved: That the report be noted.

Reason: To provide the committee with an update on school performance in the academic year 2016/17.

26. Academisation, School Organisation and Place Planning Summary

Members considered a report that provided an update on academisation in York and the councils work on school place planning.

The Assistant Director of Education and Skills gave an update and confirmed 20 York schools had converted to academy status and all apart from one had joined one of the four locally constituted multi-academy trusts (MATs), Ebor, Hope, Pathfinder or South Bank. Members noted that a fifth MAT, the South Partnership, was in the process of forming.

Members noted there were no further expressions of interest from any maintained schools to move to academisation and that the Local Authority retained a strong working relationship with all academies/multi academy trusts.

Officers stated that although figures currently showed a city wide surplus in primary school places some schools would continue to have pressure points within certain year groups as the high number of pupils admitted over the last few years made their way through their primary school education.

Officers highlighted how the council was working to ensure sufficient school places were available for current and future residents and how they forecast likely demand and supply of school places over the medium and longer term e.g. taking account of future housing developments and how new schools must be delivered at the right time.

Members thanked officers for their report and following discussions around supply and demand pressures, use of non-teaching areas and the academy schools admission policies, it was agreed that all ward Members should be kept updated to engage in future planning.

Resolved: That the report be noted.

Reason: To provide the Committee with an update on the pace of academisation and the work taking place to meet the council's statutory duty to deliver sufficient school places in its area.

27. York Museums Trust (YMT) Scrutiny Review Update

Members considered a report that updated them on the progress with developing a new legal relationship between the Council and York Museums Trust.

Members noted that a further update would be reported at a future meeting and Members agreed to email any additional questions to the Assistant Director of Communities & Equalities.

Resolved: That the report be noted.

Reason: To update Members the future legal relationship between the Council and YMT.

28. Work plan 2017/18

Members considered the Committees work plan for the 2017/18 municipal year.

Following discussion:

- The Scrutiny Officer agreed to consult with the Assistant Director of Education and Skills regarding the most appropriate time for the committee to receive an update on the interventions used to narrow the gaps.
- Cllr S Barnes agreed to email the Scrutiny Officer his proposals for undertaking a Youth Offending scrutiny review and the Scrutiny Officer would then confirm if the Children, Education & Communities Policy & Scrutiny Committee was the correct committee to consider it.

Resolved: That the work plan be noted and updated by the Scrutiny Officer, subject to the above.

Reason: To keep the Committee's work plan updated.

Cllr Taylor, Chair

[The meeting started at 5.30 pm and finished at 7.56 pm].

Children, Education & Communities Policy and Scrutiny Committee 10 January 2018

YMT Report Against Core Partnership Objectives - July to December 2017

Creation of museum and gallery provision capable of contributing to positioning York as a world class cultural centre

YMT was successful in its application to Arts Council England (ACE) to be granted National Portfolio Organisation status. As such, ACE has committed to contributing £1.2m per year to the Trust for the next four years beginning in fiscal year 2018-19. This recognition of the quality of YMT's programming, service and operations comes as competition for NPO status has increased and with some well-established museum services being denied this status and/or having their funding reduced.

YMT is creating a four-year Business Plan for the years 2018-19 to 2021-22 which indicates how the Trust will pursue and achieve the five headlines priorities from its Forward Plan 2016-2021. The Business Plan will update the Forward Plan and will specify aims and measurable targets for the teams within the Trust to realise our ambitions. One of the headlines priorities is the redevelopment of the Castle Museum and the Castle area. Planning for this initiative continues in close collaboration with CYC and the Castle Gateway Project. The appointment of an external project manager, a conservation survey and an options appraisal for the site are the next immediate steps to be taken in this process.

The Trust has received a number of awards including the following:

Visitor Attraction of the Year -- York Art Gallery (2nd year running), Visit York Tourism Awards

Gold Award -- York Museum Gardens, Yorkshire in Bloom

Excellence in Media Arts -- Viking exhibition Virtual Reality (YMT and University of York Digital Creativity Labs), York Culture Awards

Blunt Prize -- Dr. Andrew Woods, Senior Curator Yorkshire Museum, for significant contributions to the field of numismatics, British Numismatic Society

At the time of writing this report, the YMT has also been shortlisted for the following Little Viking Awards:

Best Attraction (York Castle Museum)

Best Christmas Experience (York Castle Museum)

Best Children's Festival (Eboracum Roman Festival, YMT)

Provision that is a source of inspiration and enjoyment for all and a stimulus for learning and skills development

Much of the Trust's public provision is reported in a subsequent section below, including exhibitions and online and learning offerings. However, several examples are included in this section.

With HLF funding, YMT has commissioned the author Rebecca Manley's to write a bespoke, site-specific play, entitled 'These Walls,' drawing on the stories of the Debtors' Prison to bring characters to life and challenge audiences to think about issues of justice, human rights, debt and the rights of women. York Theatre Royal Youth Theatre will perform this exciting new work in March 2018.

YMT delivered several events as part of the York Food Festival in September, bringing opportunities for learning and access to YMT collections through this popular annual festival. Especially successful was 'Behind the Scenes at the Chocolate Factory' a talk at the Castle Museum by Mike Grimes, former Terry's employee.

In December YMT delivered a discovery day for secondary school, A level students at York Art Gallery. The day, a partnership with the University of Leeds, introduced young people to research skills and supported them in giving a series of presentations on artworks in the gallery.

In partnership with Reading University, we are developing a workshop for KS 2&3 based on research into the Ivory Bangle Lady, a bronze sculpture on view in the Art Gallery. The workshop will be based on gallery on the theme of diversity and migration in Roman York focusing on Ivory Bangle Lady, Septimius Severus, Lucius Rufinus. The session is likely to be delivered to the public during the Roman Festival in June 2018.

The quality of provision at YMT is reflected, in part, by the continuing increase in visitor numbers at the Trusts' sites, in particular, the significant increase in numbers at the Yorkshire Museum in response to the Viking exhibition. This is supported by the continuing level of four- and five-star reviews on Tripadvisor. More information on visitor numbers and customer service are provided later in this report.

The protection and conservation of the collections, gardens and buildings for future generations including improved storage

Plans to address most of the Trust's remaining collections storage and management issues will be dovetailed with the Castle Museum project. The social history collection alone has c.350,000 objects, and this Designated collection is one of the best social history resources in the UK. The process of properly documenting the collection and making it accessible to staff, volunteers and researchers is ongoing.

An extensive programme of work on the trees in the museum gardens has commenced. This will entail reshaping some trees and clearing branches that are no longer viable. This is as part of a longer term strategy to conserve and maintain the safety of the trees in the Garden and to ensure that other planting is unaffected by excessive growth.

Promotion of the city's museums and collections through a varied range of activities which could include exhibitions, displays, community projects, volunteering opportunities, formal learning for schools, informal activities for families, and adult learning

YMT presented an active, high-quality exhibition programme this year. Highlights include:

York Art Gallery

Albert Moore: Of Beauty and Aesthetics (April – October)

The first monographic exhibition of York born artist Albert Joseph Moore since the memorial exhibition in 1894. The exhibition featured an impressive selection of Moore's paintings, watercolours and sketches, highlighting the beautiful and classical women for which the artist is most famous and demonstrated the modernity of his approach.

Foundation Myths (August 2016 – November 2017)

Foundation Myths was the first installation ever to be commissioned for the Artists Garden site which provides the public with free access to works of art by accomplished artists. The installation was created by Charles Holland of Ordinary Architecture, an art, architecture and design practice with an international profile. The installation, produced especially for the Garden, drew on the rich history of the site and its many uses over the centuries.

Aesthetica Art Prize 2017 (May – September)

A platform for innovation and originality, the Aesthetica Art Prize Exhibition invited audiences to engage with captivating projects from some of today's leading artists, both established and emerging.

Leisure Land Golf (June – September)

Following a successful crowdfunding campaign, York Art Gallery brought Doug Fishbone's Leisure Land Golf to the Artists Garden.

Picasso Ceramics from the Attenborough Collection (July – September)

York Art Gallery and the Centre of Ceramic Art (CoCA) displayed highlights from the Attenborough Collection of ceramics created by one of the world's most famous artists.

Marinella Senatore: York Symphony (From Sept)

Through a series of workshops and conversations collecting individual stories in York, Italian artist Marinella Senatore has created the York Symphony: an artwork that engages York's communities and culminates in a film on show in the Gallery. This new Evelyn Commission is a contemporary response to the historic Evelyn Award, a scheme which ran from 1950 until 1962 with the aim of bringing York's topographical collection up to date.

Paul Nash and the Uncanny Landscape: An Exhibition Curated by John Stezaker (From October 2017)

Paul Nash's groundbreaking inter-war landscapes which transformed the genre of British landscape painting feature in this exhibition curated by artist John Stezaker at York Art Gallery. The exhibition also includes works by Stezaker including new landscapes created in response to the themes of the uncanny landscape. A private collection of rarely seen Nash drawings, paintings, photographs and ephemera is also on display.

Yorkshire Museum

Vikings: Rediscover the Legend (May – November)

This major new partnership exhibition with the British Museum was curated by YMT and brought together objects from the YMT and the British Museum: two of the most significant and internationally recognised collections of Viking Age treasure in Britain. The exhibition is now touring across the UK.

Medieval York: Capital of the North (From November)

This installation explores how York became England's second city and how its fortunes rose and fell with its ties to the Crown and the Church. Through the finest medieval discoveries ever unearthed, including the Middleham Jewel, the Escrick ring and a Richard III supporter's Boar Badge, the latest metal detected finds and brand new research, this new display tells the only complete Medieval history of York in the city.

Castle Museum

Chocolate – York's Sweet Past (From April)

A dispersed exhibition delving into the history of some of the world's most iconic chocolates and sweets. The collections tell the story of York's key confectionary producers, including Rowntrees and Terry's, and explore how the Georgians, Victorians and the Jacobean satisfied their sweet tooth.

York St. Mary's

The Dark Self – Susan Aldsworth (May – September)

Susan Aldsworth's exhibition *The Dark Self* was inspired by her research into sleep during her three year residency at the University of York working with neuroscientist Professor Miles Whittington and art historian Professor Michael White.

Online visitors

Our digital practice plays a significant role in providing access to YMT collections. Presently we have more than 180,000 collections records and 50,000 openly-licensed images – making YMT's collection highly visible to digital audiences. In fiscal year 2017-18 we are on track to have over 700,00 unique visits to our collections pages online. Our partnerships with companies such as Google, Wikimedia UK and Sketchfab –

has resulted in YMT collections being viewed by approximately 24 million views on our collection items via those sites. These initiatives also further our headline priority to improve the Trust's profile through partnerships.

Our commitment to open licensing, allowing free access to and free re-use of a large proportion of our digital assets, also enhances access to our collections and intellectual property. YMT's approach has been lauded by the National Museum Directors' Council as the most 'radically open' institution in the UK. We have focused our efforts not only nationally but regionally as well, through the Museum Development Yorkshire network.

Learning and Volunteers

YMT's learning, volunteer and Yorkshire Museum curatorial teams took part in September's annual *Yorkshire Fossil Festival* in Scarborough. This high-profile, three-day festival was organised by Scarborough Museums Trust with funding from The Palaeontological Association. Participating institutions included; the Natural History Museum; Oxford University Natural History Museum; Leeds University, Hull University and Leicester University. YMT's activities for schools on Friday 22 September reached 120 children and 16 accompanying adults. The free family festival on the Saturday and Sunday attracted over 5,000 people.

Through its learning offerings, YMT reaches many school children and families both through specific programmes on aspects of the collections and through visits to our various sites. For the current fiscal year, we are on pace to serve 4,500 York school children who will participate in our programmes and 170,000 family programme participants. In total, over 100,000 children and young people will visit the museum this fiscal year.

An example of a more intensive, focused programme is the YMT's four-day Teenage Art School presented in July. A deliberately small number of students, eleven in this case, worked with four different artists producing sculpture, ceramics, paintings and collage. The sculptures, inspired by the work of ceramic artist Kate Haywood, are currently on display in the Project Gallery.

YMT works in partnership with other local organisations to develop and strengthen its public programme. Two examples include:

- Ethnic Minority Support Services in Selby and York – Refugee families have contributed stories inspired by buttons which will be included in a storytelling area in next year's CoCA Lucie Rie exhibition.
- YMT worked in partnership with York Theatre Royal, York Explore Libraries, York Minster and York Army Museum to deliver Arts Award Discover to local children through our family arts and craft activities over the summer holidays.

Since 1 July of this year, over 250 volunteers contributed 7,500 hours on 52 different activities throughout the Trust. Core projects such as costumed roles on Kirkgate increased as new volunteer offers came on line, and as a result of this, our volunteer Sewing Bee also expanded to meet the increased demand for authentic replica costume. The Sewing Bee have also supported the Chocolate and Shaping the Body exhibitions, by creating some authentic 'trying on' costumes for visitors, which were as wide ranging as giant Quality Street costumes to a complete Henry VIII outfit.

Increased access to the city's collections, gardens and buildings and increasing visitor numbers, especially young people

Visitor numbers from 1 July to 18 December 2017 are very positive when compared to the same period in 2016:

	Actual	Last year	% Change
York Castle Museum	140,782	133,996	+5%

Yorkshire Museum	54,711	38,773	+29%	
York St Mary's *	10,442	34,452	-30%	
York Art Gallery	42,660	38,798	+9%	
Total	<u>248,595</u>	<u>246,019</u>	+1%	* York St Mary's was open full-time throughout 2016 but just 5 days/week from June-Sept 2017.

The 'YMT Card' scheme, introduced in summer 2015, remains very popular:

- Over 50,000 'YMT Cards' have been sold to date
- There are currently 24,500 active card holders
- 55% of members are York residents, meaning 14% of adults within the CoYC boundary have purchased a YMT Card

Recognition of the special significance of the museums and gallery for York residents through the maintenance of pricing incentives for York residents and opportunities for free access

The offer to York residents has been improved in partnership with York Explore. York Card holders can still use their cards as evidence of residence to purchase YMT Cards at half price and they are now also entitled to 20% off day tickets. Alternatively, residents without York Cards can use their Council Tax bill as evidence to gain the discount on YMT Cards.

The YMT residents open days proved popular in June 2017, with nearly 3,000 additional visitors across all the sites over the weekend. We look forward to participating in the Residents Festival again in Jan 2018.

The facilitation of outreach activities and pricing mechanisms designed to encourage visits by those who do not traditionally use the museums or gallery

YMT's public programme of talks, workshops and events for adults continues to include regular sensory tours, particularly suitable to those with a sight impairment, and monthly practical, inclusive Arts for well-being sessions. Dementia, autism and deaf awareness training has been introduced for staff, and 'relaxed openings' have been introduced for people with sensory impairments.

Admission for children is free of charge at all YMT sites. Previously, thanks to a contribution from CYC, residents aged 17-24, those entitled to most forms of income related benefit, carers and community groups in excluded categories could get a YMT Card free of charge. Once this allocation was expended, the YMT decided to continue providing this benefit.

As part of the Culture & Wellbeing York project funded by City of York Council, YMT has been commissioned to support the work of the cultural sector and improve health and wellbeing outcomes in York by offering opportunities to engage in activities normally out of reach. During the period addressed in this report, the following actions have been taken:

- Creation of a 'Cultural Menu' comprising a broad range of cultural opportunities designed to improve health and wellbeing under development
- Supported the delivery of 'Cuppa and a Chorus' by the National Centre for Early Music. This programme helps reduce isolation and hopes to improve both lung and mental health
- Continued to build a referral network using the Social Prescription Service (Priority Group GP practices) and Local Area Teams
- Submitted a full application to Arts Council England's Celebrating Age programme. If successful, this would secure additional funding to support the engagement of cultural organisations with older people in the city

Excellent customer service and visitor experience

The Trust has again taken part in the Visit England Visitor Attraction Quality Assurance Scheme. Results from the mystery visits undertaken in Summer 2017 show an improvement at all sites, with all site's scores now being over 80%--the Art Gallery being the best performing with an overall score of 89%. The three sites maintain their positions in the York Tripadvisor ratings, being ranked 2nd (Castle Museum); 8th (Yorkshire Museum) and 11th (York Art Gallery) at present.

In order to accommodate visitors with access issues, the Trust has sent Front of House staff on training for working with such visitors, and we have produced information packs on how these visitors can make the most of their visit to our sites. In order to evaluate our progress in making all the sites more accessible, the Trust engaged a mystery visitor who is a wheelchair user and access consultant. Following his visits, the mystery visitor produced a report which highlighted the friendly and confident manner in which the staff engaged with him and his party. He also commended the information provided to enable a wheelchair user to best take advantage of the Trusts' offerings.

Active international partnerships to enhance public programmes, to increase YMT's and the city's reputation, and to raise funds

One of the Trust's aims is to share our collections and expertise with regional, national and international audiences. One example of an initiative in the last six months which has furthered this objective is the Trust's partnership with the British Museum, referenced above. The exhibition, *Vikings: Rediscover the Legend* presented star objects from the British Museum featured alongside the Yorkshire Museum's world class collections, with new interpretations to give a fresh perspective on how the Vikings shaped every aspect of life in Britain. The exhibition debuted at the Yorkshire Museum, is now showing in Nottingham and will travel to Southport. The exhibition also allowed the Trust to showcase its Digital Narratives for Archaeology Research (DiNAR) Project, a joint research project led by the Centre for Digital Heritage, Digital Creativity Labs and York Museums Trust. The exhibition was the first major output of the project comprising of a cinematic VR experience showing immersive vignettes of what life in the camp of the Viking Great Army at Torksey in Lincolnshire could have looked like.

Retention of registered museum status and development of the designated collections to ensure maximum public benefit

Continues. YMT now formally provides expert support and advice to other museums in the region which are seeking to renew or gain accredited museum status.

YMT has received a grant of over £71,000 from the ACE 'Designation Development Fund' to support research into the Roman collections managed by the Trust. As a result of this investment, we have been able to enrich object information with some of the latest research into York during the Roman period. During summer 2017 we ran a conference bringing together leading academics and museum curators to explore and identify opportunities for current and future research. This will help inform the redisplay of Roman collections at the Yorkshire Museum over the next couple of years. The investment will also have a more immediate public benefit by increasing the number and quality of records available online.

The maintenance of the Museum Gardens on the Register of Parks and Gardens of Special Historic Interest maintained and the register of botanical gardens

As referenced in the first section above, York Museum Gardens won another Yorkshire In Bloom Gold Award in 2017. York Museum Gardens will be an active member in the forthcoming 2018 Bloom! Festival.

Public access to the Museum Gardens daily (except relevant Christmas / New Year holidays) unless closure is necessary for reasons of public safety

This continues; additionally, the Gardens are open in the evening for the Christmas at York Museum Gardens event which is running for six weeks from mid Nov 2017.

Effective, open and transparent governance including effective access and equalities policies covering trustees and staff recruitment practices

As part of its new Business Plan, the Trust is updating its Equality Action Plan (EAP) for the years 2018-19 to 2021-22. Through the EAP, YMT aims to champion diversity throughout the Trust, with a focus on improving representation and inclusion within our audiences, communications, programme and workforce.

The YMT's Equality Action Plan will be monitored by the Trust's Senior Management Team (SMT). The SMT reviews progress against plans each quarter and ensures that the organisation is on track to achieve its objectives. The YMT Board also monitors progress against plans and policies at their regular board meetings, held six times per year. The Success Indicators in this plan will be incorporated into the organisation's KPI report which is monitored by the board on a quarterly basis.

We run fair and transparent selection processes for both Trustees and staff. Trustee vacancies are advertised and board diversity is an important consideration in recruitment. For staff posts, HR representatives are present on each interview panel, questions are submitted to HR in advance and all candidates receive the same information and are asked the same questions. The system of Personal Development Reviews means that routes to training are also open and fair.

This page is intentionally left blank

York Museums Trust

Five Year Revenue Forecast - £'000

	Indicative Forecast Total 2018/19	Indicative Forecast Total 2019/20	Indicative Forecast Total 2020/21	Indicative Forecast Total 2021/22	Indicative Forecast Total 2022/23
Income					
Admissions	2603	2627	2648	2669	2690
YMT Card Sales	403	445	487	487	487
Gift Aid	308	330	337	339	341
ACE MPM / NPO	1230	1230	1230	1230	1230
CYC (General Revenue)	300	300	300	300	300
Enterprises Income	1456	1525	1601	1681	1765
Museum Development	339	339	339	339	339
Other Unrestricted Income	267	304	327	351	375
Total General Fund Income	6906	7099	7268	7396	7527
Costs incurred by Enterprises	1066	1114	1125	1137	1148
Fundraising	56	57	57	57	57
Charitable Expenditure					
Curatorial	647	658	660	662	664
Learning	401	407	409	411	414
Exhibitions & Events	604	675	735	745	755
Gardens	225	227	228	229	230
Marketing	497	501	506	512	518
Premises	656	671	682	693	704
Visitor Services	1026	1044	1047	1050	1054
Admissions	130	132	133	133	133
Trust Central Costs	1176	1173	1194	1216	1238
Museum Development	341	341	341	341	341
	5704	5830	5936	5993	6051
Total General Fund Expenditure	5760	5886	5993	6050	6108
Increase in General Reserve	80	99	150	209	271
B/F General Reserve	2215	2296	2394	2545	2754
C/F General Reserve	2296	2394	2545	2754	3025

This page is intentionally left blank



Children, Education & Communities Policy & Scrutiny Committee

10 January 2018

Report of the Corporate Director of Children, Education & Communities

2017/18 Finance and Performance Second Quarter Report – Children, Education & Communities

Summary

- 1 This report analyses the latest performance for 2017/18 and forecasts the financial outturn position by reference to the service plans and budgets for all of the services falling under the responsibility of the Corporate Director of Children, Education & Communities.

Financial Analysis

- 2 A summary of the service plan variations is shown at table 1 below.

Table 1 – CEC Financial Projections Summary 2017/18 – Quarter 2

2017/18 Quarter One Variation £000		2017/18 Latest Approved Budget			2017/18 Projected Outturn Variation	
		Gross Spend £000	Income £000	Gross Spend £000	£000	%
-126	Children's Specialist Services	22,094	1,139	20,955	+149	+0.7%
-12	Communities & Equalities	9,100	4,252	4,848	+16	+0.3%
-142	Education & Skills	19,309	9,367	9,942	-194	-1.9%
+447	School Funding & Assets	117,565	124,451	-6,886	+316	+4.6%
+177	Director of CEC & Central Budgets	1,160	5,882	-4,722	+111	+2.4%
+344	Total CEC Directorate	169,228	145,091	24,137	+398	+1.7%

+ indicates increased expenditure or reduced income / - indicates reduced expenditure or increased income

- 3 The following sections provide more details of the significant outturn variations.

Children's Specialist Services (+£149k / 0.7%)

- 4 Children's Social Care (CSC) staffing budgets are currently projecting a net overspend of £115k, mainly due to relatively expensive agency staff being used to cover important but hard to fill social worker posts. In light of this, and as reported to Staffing & Urgency Committee in July, additional unbudgeted costs of £59k will be incurred this year paying 'golden hello' and 'golden handcuff' payments to new and existing staff in the referral and assessment team, along with a major social work recruitment advertising campaign estimated at £30k.
- 5 Based on the current numbers of Looked After Children (LAC) being maintained throughout the rest of the year there is a net projected overspend on placement costs of £200k, including +£192k on local fostering, +£89k on Inter Agency Adoption Fees and +£161k on Adoption and Special Guardianship Order allowances. This is offset by a net projected underspend of £176k on out of city placements and £66k on Leaving Care costs.
- 6 There is a net projected overspend of £93k within The Glen and disability short breaks budgets, due mainly to delays in implementing the new model of provision for children with the most complex needs that was planned to deliver a budget saving in 2017/18.
- 7 Within the Dedicated Schools Grant (DSG) funded Special Educational Needs budgets there is a net projected underspend of £328k. This is mainly due to savings on out of city education placements in light of the on-going efforts to support as many young people as possible in York.
- 8 Education Psychology budgets are projected to underspend by £43k mainly due to difficulties being experienced in recruiting to some psychologist posts. A number of other more minor variations make up the remaining projected net overspend of £23k.

Communities & Equalities (+£12k / 0.3%)

- 9 There are currently no significant variations to report.

Education & Skills (-£194k / 1.9%)

- 10 Local Area Teams budgets are projecting a net £349k underspend, mainly due to the early delivery of the full £1.4m saving in advance of the final £300k budget being removed from 2018/19. There is a net projected underspend of £97k within School Improvement due to a number of staffing vacancies, particularly within the Skills Team, but offset by some additional costs including for the LAC virtual school headteacher.

- 11 Home to School Transport budgets are currently projected to overspend by a net £274k. There are significant pressures within SEN taxi budgets where contract inflation has been higher than expected, and additional costs may be being incurred as more high needs pupils return to the city as a result of the Make York Home project, resulting in not all of the savings planned for 2017/18 being delivered. This is partly offset by some small additional savings on mainstream school bus contracts. A number of other more minor variations make up the remaining projected net underspend of £22k.

Schools Funding & Assets (+£316 / 4.6%)

- 12 The net projected variation is made up of the following items:
- a carry forward of surplus DSG from 2016/17 that is £266k higher than budgeted for,
 - a projected saving of £350k on prudential borrowing repayments as the provision set aside following the closure of Burnholme Community College has not yet been committed;
 - a projected £250k write off of school deficits for schools converting to sponsored academy status;
 - a revised projected surplus carry forward of DSG into 2018/19 of £682k.

Director of CEC and Central Budgets (+£111k / 2.4%)

- 13 Following the early delivery of some budget savings, there is additional pressure on the directorate's £100k budget for early retirement and redundancy costs. Although the majority of the costs will be more than offset by the savings achieved, a one off over spend of £150k is forecast for 2017/18. A number of other more minor variations make up the remaining projected net underspend of £39k.

Performance Analysis

Number of Children Looked After

- 14 There were 195 children and young people in care at the end of September 2017. This evidences a continued consistency of practice and need, against the national trend of increasing looked after numbers.
- 15 The stability of placements of children and young people in care has shown consistent improvement over the last three years, with the number of children experiencing three or more moves of placement falling to 4% by the end of Q2 from nearly 12% in 2014/15.
- 16 In line with national trends, York has been facing challenges with recruiting foster carers and has launched a new approach to encourage people to foster. Partnership working with 'You Can Foster' has improved enquiry rates, with 36

enquires received in Q2 2017/18 compared to 10 enquiries during the same period last year.

Average Progress 8 score from Key Stage 2 to Key Stage 4

- 17 Progress 8 is a measure of the progress made by pupils between Key Stage 2 and selected subjects at GCSE. It is calculated for every pupil and progress in English and Maths is double weighted. A positive score represents progress above the average for all pupils and a negative score progress below the average for all pupils.
- 18 In 2017, the average Progress 8 score for Year 11 pupils was slightly above the national average and an improvement on 2016. Provisional results show that York compares well with regional results.
- 19 Building on the success of our six school primary writing project, which contributed to improved Key Stage 2 outcomes in 2017, we joined Pathfinder Teaching School Alliance and Huntington Research School in a bid for funding to the DfE Strategic School Improvement Funding for a larger project starting in January 2018. The bid was successful and realised £196k to deliver a programme of intensive training and support across at least 14 schools this year. The project will expand to include a further group of schools in 2018-19.

%pt gap between FSM and non-FSM pupils at 15, who attain a Level 3 qualification by the age of 19

- 20 Attainment at age 19 remains generally positive however there have been concerns about the outcome gap between both disadvantaged young people and young people with Special Educational Needs (SEN) and their peers. Latest figures from April 2017 show the attainment gap is closing in some areas and, to address remaining challenges, Further Education providers will be worked with and strategically supported by the council to sustain focus on these groups.
- 21 In addition, Learning and Work Advisers from the council's Local Area Teams will provide specialist information, advice and guidance to young people who are in the care of the local authority, those in alternative education provision, those in the youth justice system, and those aged 16-18 who are Not in Employment, Education or Training (NEET). Appointments and group work will be available at locations across the city based on local need and will complement the careers guidance and support provided through schools and other education providers under their statutory duties.

Voice and Involvement

- 22 The Youth Council have drafted and agreed a new constitution which includes three distinct work groups focusing on campaigns, consultation and

engagement. Elections have also taken place for the positions of Chair, Vice Chair and Treasurer. Training has been undertaken focusing on consultation with CYC and the Future Plan/Key Decisions. The consultation group will take an active role in providing an offer of consultation and the views of young people on key decisions that affect young people in York. The Youth Council will be carrying out a review of their constitution at the end of November and will make any necessary changes.

- 23 A 'Make your Mark' ballot has been completed this year and for the first time, in addition to secondary schools, colleges and targeted groups have also been consulted. 'Make your Mark' is a national ballot where young people across the country are asked which issues matter most to them, in order to determine what is debated by the UK Youth Parliament (UKYP) in the House of Commons on 11th November. These groups included Show me that I matter, the Virtual School, Danesgate, York Learning, YOT, York and Askham Bryan College, the Apprenticeship Event, 30 Clarence Street and Young Carers.
- 24 The Primary Voice event was held at City of York Council on June 26 with children from 18 primary schools present. Discussions between local councillors and the schoolchildren covered a wide variety of topics, from how the children would manage the council budget to their ideas on parks and school meals. The report has been fed back to Councillors and was well received. A Secondary Voice event has been arranged for Wednesday 15th November and will include opportunities for the Young People to again meet with Councillors from each of the three main parties as well as opportunities to consult on the York Central Project, The Healthy Child Service and this years York Youth Council campaigns.

Council Plan

- 25 This report is directly linked to the three key priorities of the Council Plan for 2015-19: A Prosperous City for All; A Focus on Frontline Services; and A Council that Listens to Residents.

Implications

- 26 The financial implications are covered within the main body of the report. There are no other direct implications arising from this report.

Recommendations

- 27 As this report is for information only there are no specific recommendations.

Reason: To update the committee on the latest financial and performance position for 2017/18.

Contact Details

Authors:

Richard Hartle
Finance Manager
Adults, Children &
Education

Phone: 01904 554225
richard.hartle@york.gov.uk

Chief Officer Responsible for the report:

Jon Stonehouse
Corporate Director of Children, Education &
Communities

Will Boardman
Strategy & Policy Group
Manager
Phone: 01904 553412
will.boardman@york.gov.uk

**Report
Approved**

Date 22 December 2017

Specialist Implications Officer(s) None

Wards Affected: *List wards or tick box to indicate all*

All

For further information please contact the authors of the report

Background Papers

2017/18 Finance and Performance Monitor 2 Report, Executive 15 November 2017

Annexes

Annex A: 2017/18 Monitor 2 Performance Scorecard



Children, Education & Communities 2017/2018

No of Indicators = 47 | Direction of Travel (DoT) shows the trend of how an indicator is performing against its Polarity over time.

Produced by the Strategic Business Intelligence Hub January 2018

			Previous Years			2017/2018						
			2014/2015	2015/2016	2016/2017	Q1	Q2	Q3	Q4	Target	Polarity	
		Collection Frequency										
Children's Social Care - Children Looked After	148	% of care leavers in employment, education or training aged 17-21 (19-21 until 2016/2017)	Monthly	57.50%	68.00%	75.64%	-	-	-	-	-	Up is Good
		Benchmark - National Data	Annual	48.00%	49.00%	-	-	-	-	-	-	
		Benchmark - Regional Data	Annual	53.00%	-	-	-	-	-	-	-	
		Benchmark - Comparator Data	Annual	49.20%	-	-	-	-	-	-	-	
	EFL1	Children Looked After per 10k - (Snapshot)	Monthly	53	53	55	54	52	-	-	-	Neutral
		Benchmark - National Data	Annual	60	60	62	-	-	-	-	-	
		Benchmark - Regional Data	Annual	64	63	67	-	-	-	-	-	
		Benchmark - Comparator Data	Annual	53	54	57	-	-	-	-	-	
		Number of Children Looked After - (Snapshot)	Monthly	193	191	204	200	191	-	-	-	Neutral
Children's Social Care - Safeguarding	64	% of children ceasing to be the subject of a Child Protection Plan who had been the subject of a CPP continuously for two years or longer - (YTD)	Monthly	9.50%	2.80%	2.73%	6.00%	7.00%	-	-	-	Up is Bad
		Benchmark - National Data	Annual	3.70%	3.80%	3.40%	-	-	-	-	-	
		Benchmark - Regional Data	Annual	-	-	2.00%	-	-	-	-	-	
	65	% of children becoming the subject of a Child Protection Plan for a second or subsequent time - (YTD)	Monthly	12.20%	25.70%	28.38%	41.00%	36.00%	-	-	-	Up is Bad
		Benchmark - National Data	Annual	16.60%	17.90%	18.70%	-	-	-	-	-	
	EFL2	Children with a Child Protection Plan per 10k - (Snapshot)	Monthly	34	37	46	41	37	-	-	-	Neutral
		Benchmark - National Data	Annual	42.9	54.2	43.3	-	-	-	-	-	
		Benchmark - Regional Data	Annual	41.8	52.1	43	-	-	-	-	-	
		Number of Children with a Child Protection Plan - (Snapshot)	Monthly	124	135	171	151	138	-	-	-	Neutral
Crime	CSP01	All Crime (QUANTA data)	Monthly	10,807	12,015	11,221	3,004	3,111	-	-	-	Up is Bad
	CSP15	Overall Violence (Violence Against Person Def.)	Monthly	2,130	2,513	2,509	716	916	-	-	-	Up is Bad
		IQUANTA Family Grouping (Rank out of 15)	Monthly	6	6	4	4	1	-	-	-	
Crime Anti S	CSP13	NYP Recorded ASB Calls for Service	Monthly	9,306	8,997	8,860	2,178	2,242	-	-	-	Up is Bad

New Social Indicator	CSP28	Number of Incidents of ASB within the city centre ARZ	Monthly	2,576	2,305	2,175	487	539	-	-	-	Up is Bad	
	Crime - Hate Crime	CSP23	Hate Crimes or Incidents as Recorded by NYP	Monthly	108	141	189	69	64	-	-	-	Up is Bad
Crime - Key Places			IQUANTA Family Grouping (Rank out of 15)	Monthly	3	5	6	6	7	-	-	-	
	Crime - Key Places and Poverty	CSP29a	Number of Incidents of ASB within the CIZ	Monthly	1,808	1,518	1,399	276	356	-	-	-	Up is Bad
Deprivation		CSP29b	Number of Incidents of Alcohol Related ASB within the CIZ	Monthly	-	-	594	131	130	-	-	-	Up is Bad
	CJGE13A	Percentage of Children (aged 0- 15) living in Out-of-work Benefit Claimant Households	Annual	9.38%	8.74%	8.38%	-	-	-	-	-	Up is Bad	
		Benchmark - National Data	Annual	16.22%	14.74%	14.04%	-	-	-	-	-	-	
Benchmark - Regional Data		Annual	18.98%	17.46%	16.80%	-	-	-	-	-	-		
Education (Adult)	CJGE17	% of working age population qualified - No qualifications	Annual	4.90%	4.60%	6.20%	-	-	-	-	-	Up is Bad	
	CJGE18	% of working age population qualified - to at least L2 and above*	Annual	82.50%	81.10%	80.20%	-	-	-	-	-	Up is Good	
		Benchmark - National Data	Annual	73.30%	73.60%	74.30%	-	-	-	-	-	-	
		Benchmark - Regional Data	Annual	70.00%	70.10%	71.00%	-	-	-	-	-	-	
		Regional Rank (Rank out of 15)	Annual	1	1	1	-	-	-	-	-	-	
	CJGE19	% of working age population qualified - to at least L3 and above*	Annual	66.80%	65.80%	65.20%	-	-	-	-	-	Up is Good	
		Benchmark - National Data	Annual	55.00%	55.80%	56.90%	-	-	-	-	-	-	
		Benchmark - Regional Data	Annual	50.00%	51.30%	52.30%	-	-	-	-	-	-	
		Regional Rank (Rank out of 15)	Annual	1	1	1	-	-	-	-	-	-	
	CJGE20	% of working age population qualified - to at least L4 and above*	Annual	40.30%	40.60%	42.70%	-	-	-	-	-	Up is Good	
		Benchmark - National Data	Annual	36.00%	37.10%	38.20%	-	-	-	-	-	-	
		Benchmark - Regional Data	Annual	29.80%	30.60%	31.30%	-	-	-	-	-	-	
Regional Rank (Rank out of 15)		Annual	1	1	1	-	-	-	-	-	-		
Education (Young People)	ES8	% of After School Clubs achieving 'good' or 'outstanding' - (Snapshot)	Annual	84.00%	83.00%	-	-	-	-	-	-	Up is Good	
	ES9	% Take up of early education places by eligible two year olds - (Snapshot)	Annual	70.00% (350)	72.00% (392)	73.50% (382)	-	-	-	-	-	Up is Good	
Educational Attainment	81	%pt gap between FSM and non-FSM pupils at 15, who attain a Level 3 qualification by the age of 19 - (Snapshot)	Annual	41.70%	32.00%	(Avail Apr 2018)	-	-	-	-	-	Up is Bad	
		Benchmark - National Data	Annual	24.60%	24.50%	(Avail Apr 2018)	-	-	-	-	-	-	
		Benchmark - Regional Data	Annual	27.30%	27.60%	(Avail Apr 2018)	-	-	-	-	-	-	
		Regional Rank (Rank out of 15)	Annual	15	13	(Avail Apr 2018)	-	-	-	-	-	-	
	82	%pt gap between FSM and non-FSM pupils at 15, who attain a Level 2 qualification by the age of 19 - (Snapshot)	Annual	19.20%	14.20%	(Avail Apr 2018)	-	-	-	-	-	Up is Bad	
		Benchmark - National Data	Annual	16.50%	17.50%	(Avail Apr 2018)	-	-	-	-	-	-	
		Benchmark - Regional Data	Annual	19.80%	20.60%	(Avail Apr 2018)	-	-	-	-	-	-	

		Regional Rank (Rank out of 15)	Annual	7	3	(Avail Apr 2018)	-	-	-	-	-	
	KS4a	Average Progress 8 score from KS2 to KS4	Annual	-	0.04	0.11	-	-	-	-	-	Up is Good
		Benchmark - National Data	Annual	-	-0.03	-0.03	-	-	-	-	-	
Homelessness	HOU102	Number of homeless households with dependent children in temporary accommodation - (Snapshot)	Quarterly	41	30	33	34	36	-	-	-	Up is Bad
		Number of children in temporary accommodation (snapshot)	Quarterly	69	46	58	64	62	-	-	-	Up is Bad
Libraries	LIB01	Library Visits - All Libraries	Monthly	799,083	997,606	1,025,480	255,626	292,534	-	-	-	Up is Good
	LIB02	Books Borrowed - All Libraries	Monthly	778,615	819,179	800,300	192,356	214,540	-	-	-	Up is Good
NEET	117c	% of Year 12-13 (academic age 16-17) young people who are not in education, employment or training (NEET) - (Snapshot)	Monthly	-	-	3.30%	3.20%	1.90%	-	-	-	Up is Bad
		Benchmark - National Data	Quarterly	-	-	3.00%	3.10%	1.90%	-	-	-	
		Benchmark - Regional Data	Quarterly	-	-	3.40%	3.60%	2.10%	-	-	-	
		Benchmark - Comparator Data	Quarterly	-	-	2.40%	2.60%	1.60%	-	-	-	
	NEET02c	% of Year 12-13 (academic age 16-17) NEET who possess less than a L2 qualification (New definition Jan 2017) - (Snapshot)	Monthly	-	-	85.00%	84.20%	89.20%	-	-	-	Up is Bad
Obesity	NCMP01	% of reception year children recorded as being obese (single year)	Annual	7.03%	8.59%	8.52%	-	-	-	-	-	Up is Bad
		Benchmark - National Data	Annual	9.08%	9.31%	9.61%	-	-	-	-	-	
		Benchmark - Regional Data	Annual	8.83%	9.42%	9.72%	-	-	-	-	-	
		Regional Rank (Rank out of 15)	Annual	1	2	4	-	-	-	-	-	
	NCMP02	% of children in Year 6 recorded as being obese (single year)	Annual	14.97%	15.14%	16.13%	-	-	-	-	-	Up is Bad
		Benchmark - National Data	Annual	19.08%	19.82%	19.98%	-	-	-	-	-	
		Benchmark - Regional Data	Annual	19.19%	20.29%	20.42%	-	-	-	-	-	
		Regional Rank (Rank out of 15)	Annual	1	1	1	-	-	-	-	-	
Physical Activity	PHOF01	% of physically active and inactive adults - active adults	Annual	62.18%	69.83%	70.24%	-	-	-	-	-	Up is Good
		Benchmark - National Data	Annual	57.04%	57.05%	60.58%	-	-	-	-	-	
		Benchmark - Regional Data	Annual	56.08%	56.35%	59.45%	-	-	-	-	-	
		Regional Rank (Rank out of 15)	Annual	2	1	1	-	-	-	-	-	
Projects - Large	CORP10L	Large Project - Provision of School Places	Quarterly	-	-	-	NC	Green	-	-	-	Neutral
		Large Project - Specialist Disabled Children Short Break Facility	Quarterly	-	-	-	NC	Green	-	-	-	Neutral
Public Health and Maternity	CHP30	Hospital admissions for asthma (0-18 years), per 100,000 population	Annual	124.94	101.62	-	-	-	-	-	-	Up is Bad
		Benchmark - National Data	Annual	216.12	202.39	-	-	-	-	-	-	
		Benchmark - Regional Data	Annual	209.44	161.6	-	-	-	-	-	-	
		% of births registered within 42 days	Monthly	98.00%	98.00%	98.00%	-	-	-	-	-	Up is Good

Public Protection	PP08	Benchmark - National Data	Monthly	-	97.00%	96.00%	-	-	-	-	-	
		Benchmark - Regional Data	Monthly	-	98.00%	98.00%	-	-	-	-	-	
	PP09	% of still births registered within 42 days	Monthly	100.00%	100.00%	100.00%	-	-	-	-	-	Up is Good
		Benchmark - National Data	Monthly	-	99.00%	99.00%	-	-	-	-	-	
		Benchmark - Regional Data	Monthly	-	99.00%	99.00%	-	-	-	-	-	
	PP10	% of deaths registered within 5 days	Monthly	93.00%	90.00%	85.00%	-	-	-	-	-	Up is Good
Benchmark - National Data		Monthly	-	76.00%	78.00%	-	-	-	-	-		
Benchmark - Regional Data		Monthly	-	85.00%	84.00%	-	-	-	-	-		
Resident and Corporate Surveys	TAP11	% of panel who agree that they can influence decisions in their local area	Quarterly	NC	NC	25.65%	28.41%	NC	-	-	-	Up is Good
		Benchmark - Community Life Survey	Annual	35.00%	36.00%	26.53%	-	NC	-	-	-	
	TAP13	% of panel who give unpaid help to any group, club or organisation	Quarterly	NC	NC	64.30%	66.44%	NC	-	-	-	Up is Good
		Benchmark - Community Life Survey	Annual	69.00%	70.00%	62.68%	-	NC	-	-	-	
Safeguarding Young People	PHOF06	Under 18 conceptions (per 1,000 females aged 15-17) (Calendar Year)	Quarterly	15.71	20.41	-	-	-	-	-	-	Up is Bad
		Benchmark - National Data	Quarterly	22.8	20.78	-	-	-	-	-	-	
School Strategy and Planning	PriFSM	% of children who are eligible for a free school meal in the primary sector (excluding Danesgate)	Annual	8.40%	8.60%	7.80%	-	-	-	-	-	Neutral
		Benchmark - National Data	Annual	15.60%	14.50%	14.10%	-	-	-	-	-	
		Benchmark - Regional Data	Annual	16.60%	15.70%	15.90%	-	-	-	-	-	
	SecFSM	% of eligible children taking a free school meal in the primary sector (excluding Danesgate) - (Snapshot)	Annual	83.70%	78.30%	77.27%	-	-	-	-	-	Neutral
		% of children who are eligible for a free school meal in the secondary sector (excluding Danesgate)	Annual	6.70%	6.30%	6.20%	-	-	-	-	-	Neutral
		Benchmark - National Data	Annual	13.90%	13.20%	12.90%	-	-	-	-	-	
		Benchmark - Regional Data	Annual	15.00%	14.50%	14.70%	-	-	-	-	-	
	% of eligible children taking a free school meal in the secondary sector (excluding Danesgate) - (Snapshot)	Annual	78.00%	78.20%	78.04%	-	-	-	-	-	Neutral	
Tourism	TOU01	Room Occupancy	Monthly	74.76%	66.50%	79.24%	82.60%	87.27%	-	-	-	Up is Good
	TOU04	Average Room Rate	Monthly	£69.66	£74.18	£95.09	£102.5	£112.26	-	-	-	Neutral
	TOU08	Visits to Attractions: Big Attractions	Monthly	2,866,401	2,597,009	2,376,573	674,377	822,293	-	-	-	Up is Good
	TOU09	Visits to Attractions: Small Attractions	Monthly	276,399	247,538	232,501	87,844	93,238	-	-	-	Up is Good
	TOU14	Parliament Street Footfall	Monthly	9,616,941	8,356,697	8,044,607	2,058,005	2,226,500	-	-	-	Up is Good
	TOU15	Visitor Information Centre Footfall	Monthly	488,643	431,346	401,206	102,556	125,201	-	-	-	Up is Good
Youth		% of young people ending their YOT supervised order who are NEET (New definition from 2013/14 - cumulative) - (YTD)	Discontinued	19.50%	26.20%	-	-	-	-	-	-	Up is Bad

Offending	45	% of 10-16 year olds ending their YOT supervised order who are NEET - (YTD)	Discontinued	0.00%	0.00%	-	-	-	-	-	-	Up is Bad
		% of 16+ year olds ending their YOT supervised order who are NEET - (YTD)	Discontinued	26.80%	39.30%	-	-	-	-	-	-	-

This page is intentionally left blank



Children, Education & Communities Policy & Scrutiny Committee

10 January 2018

Report of the WW1 Commemoration Scrutiny Review Task Group

WW1 Commemorations 2018 Scrutiny Review Draft Final Report

Summary

1. This draft final report presents the findings of the Scrutiny Review into the city's plans for commemorating the centenary of the end of World War One (WW1). The Committee are asked to consider and endorse the Task Group's draft recommendations ahead of this report being presented to the Executive on 25 January 2018.

Background

2. In March 2017 Council considered a Motion proposed by Cllr Steward which stated:

'Council notes that 2018 will mark 100 years since the ceasing of the hostilities in the Great War;

Council recognises that residents of York will wish to commemorate this event and to express their appreciation to all who sacrificed so much during that conflict;

Council therefore invites the Leader and Deputy Leader to set up a working group to coordinate a series of commemorative events for next year, such working group to include, at their discretion, councillors, officers, civic leaders, organisations representing the armed forces and similar groups; artists and residents. The working group will plan an overall strategy for the council's commemoration activities, determine and address its funding needs as the steering group deem appropriate. Council further instructs that the working group should ensure that the programme of activities fully reflects the following:

- *The horrors of war, including the suffering caused by the 37 million military and civilian casualties during the First World War;*
- *A diversity of perspectives on the causes and consequences of the war;*

- *A commitment to learn the lessons of the past to help build peace in the future.'*

3. Council agreed a Member Working Group should be formed to carry out the coordination work as described in the Motion above. However, by late July 2017 a Working Group had yet to be formed and so mindful of the limited time available, this Committee agreed to form a Scrutiny Review Task Group to progress the required work.

Information Gathered

4. The Task Group made up of Cllrs Steward, Mason, Taylor and Wells met for the first time in August 2017. The Assistant Director (Communities & Equalities) provided information on previous events and commemorations that the Council had facilitated e.g. the 50th anniversary commemorations for Victory in Europe and Victory in Japan, and the annual Holocaust Memorial Day, including the budget requirements for those events.
5. In addition, the Task Group discussed some of the many events and exhibitions that had been held across the country or that had been ongoing since 2014 to commemorate WW1 and/or mark the centenary of its start. For example, York Museums Trust had an ongoing 1914-1918 exhibition.

Consultation

6. The Task Group agreed any plans should involve as many residents and citywide organisations as possible. They also agreed it would be useful to understand what if any plans were already in place across the city, and agreed to write to a range of organisations to gather their views and record their plans. The following organisations were contacted:

- Archbishop of York
- Dean of York Minster
- All Churches
- York Interfaith Forum
- North Yorkshire Police
- North Yorks Fire & Rescue Service
- North Yorks Ambulance Service
- Armed Force Community Covenant Network
- All Schools
- University of York
- York St John University
- All CYC Cllrs
- All Alderman
- MP Rachael Maskell
- MP Julian Sturdy
- Civic Party
- Mansion House
- All York Guilds
- CYC Community Involvement Officers
- Parish Councils
- Residents Associations
- Make it York

- Cultural Leaders Group
- National Trust
- York Archaeological Trust
- English Heritage
- York Museums Trust
- York Army Museum
- Yorkshire Air Museum
- Yorvik
- York Explore
- York@Large
- Civic Trust
- Aesthetica
- National Centre for Early Music
- Pilot Theatre
- York Theatre Royal
- Grand Opera House
- York Barbican
- City Screen

7. A number of the organisations provided an initial response. In addition, the Task Group issued a press release and used the Council's social media channels to advertise its work. This generated further feedback from the public.
8. See Annex A for a summary of feedback received.

Analysis

9. The Task Group were pleased to note the level of interest that their initial communication had generated and the amount of positive feedback they had received which included some details on plans already in place for 2018 and ideas for additional events.
10. The Task Group agreed that the Council's primary role should be to facilitate the coordination of a programme of events organised by others, and help in the promotion of those events to residents and visitors. It was agreed that this should include the production of both a printed programme as well as web-based information.
11. The Task group agreed that the programme should focus on the period between 1 October 2018 and Armistice Day on Sunday 11 November 2018, culminating in a civic ceremonial procession, a laying of wreaths and a service in the Minster.
12. The Task Group agreed that the Council should seek to facilitate a programme that, in addition to a civic component, includes contributions from:
 - The military
 - The business community
 - The city's faith communities

13. The Task Group noted that there are a number of potential civic contributions to the programme including use of the Mansion House. This might include exhibiting items from the WW1 period from within its historic collection and displaying information on:
 - the civic party of the time
 - how the Mansion House was used during the war
 - the Council and the city's contribution to the war effort
14. The Task Group agreed that the work would require a budget of £10k, the majority of which could be used to procure the services of an event organiser to carry out the work associated with the production of a programme and any costs associated with the activities proposed in paragraph 12 above. The Task Group therefore drafted a brief for the post for the Committee's consideration – see Annex C.
15. The Task Group agreed that the remainder of the budget could be used to support the involvement of the Mansion House and/or any other emerging ideas.
16. Finally, the Task Group suggested that a Reference Group be formed to support the Event Organiser in their work. They agreed the Group should include the AD for Communities, Culture & Public Realm with a number of CYC Councillors and representatives from those external bodies who have expressed an interest in being involved – see consultation feedback.
17. To further explore and develop the ideas generated as a result of the Task Group's publicity and to recruit to and establish the Reference Group, the Task Group agreed that an open meeting should be held at the end of January.

Options

18. The Scrutiny Committee may choose to either endorse the draft recommendation contained in this report or identify alternative recommendation(s) for presentation to the Executive.

Council Plan

19. As part of the review the Task Group sought the views of a range of partner organisations, community groups and children and young people thereby demonstrating the Council's commitment to listen to residents,

which is one of the Council's corporate priorities, as set out in the Council's Plan 2015-19.

Implications

20. Financial – The financial implications associated with the recommendation arising from this review and detailed in paragraph 13 above.
21. There are no other known HR, Equalities, Legal, Crime & Disorder or other implications associated with the review recommendations listed at paragraph 20 of this report.

Risk Management

22. There are no known risks, associated with the recommendations arising from this review.

Recommendations

23. As a consequence of their review, the Task Group agreed to recommend that:
 - i. The Executive provide a budget of £10k to enable the procurement of an event organiser to develop and promote a programme of events to commemorate the end of WW1, in line with the brief shown at Annex C.
 - ii. A Reference Group be set up to support and steer the work of the Event Organiser, with its membership as suggested in paragraph 15 above.

Reason: To ensure the City reflects the appreciation of its residents to all those who sacrificed so much during the conflict, and to conclude this review in line with scrutiny procedure and protocols.

Contact Details

Author:

Melanie Carr
Scrutiny Officer
Scrutiny Services
Tel.01904 552054

Chief Officer Responsible for the report:

Andrew Docherty
Assistant Director, Legal & Governance

Report Approved **Date** 18 Dec 2017

Specialist Implications Officer:

Charlie Croft, AD Communities and Equalities

Wards Affected:

All



For further information please contact the author of the report

Background Papers: Not Applicable

Annexes:

A – Feedback from formal consultation

B – Draft brief for event organiser

Report Abbreviations:

Cllr – Councillor

WW1 – World War One

WW1 Commemorations Scrutiny Review

Responses to Consultation

1. a. York City Centre Churches – Revd Jane Nattress
b. Email Attachment Butchers Bell Installation
2. Council Leader & Copmanthorpe PC member - Cllr David Carr
3. Make it York MD – Steve Brown
4. Civic Team – Danielle Bond
5. Explore York – Fiona Williams
6. NCEM – Delma Tomlin
7. Church of Latter Day Saints – Mark Cosens, Regional Director of Public Affairs
8. Merchants Adventurers - Jo Wright
9. a. Email 1 - Bishopthorpe Parish Council –Carole Green, Chair
b. Email 2 - Bishopthorpe Parish Council’s Plans
10. St Mary’s Church Bishophill – Graeme Thomas Churchwarden
11. Alderman Steve Galloway
12. Askham Richard Parish Council – Sara Mason, Chair
13. The Rowntree Society – Bridget Morris
14. York St John University – Dawn Hallaways, Executive Officer to Vice Chancellor
15. Upper Poppleton Parish Council – Stuart Robson, Chair
16. Gild of Freemen of York – Tom Gibson, Clerk
17. Anglican Church Congregation, Copmanthorpe - Revd Julie Skitt
18. a. York Army Museum – Allison Freeman, Learning & Engagement Officer
b. Email Attachment – ‘Battles Over’ Guide to Taking Part
19. York Guild of Building – Rosemary Mitchell, Clerk
20. Company of Merchant Adventurers – Capt Stephen Upright, Clerk
21. York Mansion House – Danielle Bond
22. National Railway Museum – Chris Keady
23. Copmanthorpe Parish Council – Brian Bell
24. Yorkshire Museum of Farming – Dan Kirk
25. JR Villar

26. Fishergate, Fulford & Heslington Local History Society – Christopher Rainger

From: Natrassiane@aol.com
To: WW1Commemorations2018@york.gov.uk
Subject: Re: Plans for the Commemoration of WW1 in York in 2018
Date: 17 November 2017 17:54:58
Attachments: [Butchers Bell installation Ring for Peace.docx](#)

Thank you for your e mail regarding plans for the commemoration of the 100th anniversary of Armistice Day on 11 Nov 2018.

I would be pleased to see what others are planning and a round table meeting sounds like a good way to do this. Delma Tomlin, from NCEM, called a meeting some years ago about WW1 and has built up an archive so she would be a good contact to start the conversation. delma.tomlin@ncem.co.uk

In our churches, we have started to formulate and implement some plans for the anniversary:-

1. York Peace Bells - these are already in position at Holy Trinity Goodramgate, St Paul's Bookshop and in the Merchant Adventurers' Garden (the latter will be moved to Holy Trinity Micklegate soon). Information attached. Nearer the time, we will put information about the WW1 bell story beside the bells.

2. We have bought banners with the poppy emblem for the lantern at All Saints Pavement. These were installed in 2017 and have now been taken down. We will use them again in 2018

3. We have launched a Poppy Project asking people to make poppies and keep hold of them until Sept 2018. At that point we will bring groups of people together to attach the poppies to camouflage netting. The whole of the outside of All Saints Pavement Church will be covered with the netting and poppies with sandbags around the base to make an art installation for 30 days leading up to 11 Nov 2018. E mail address is Poppies2018@aol.com Knitting/crocheting patterns can be found on All Saints Pavement website <https://www.allsaintspavement.org.uk/poppy-project-2018.html>

This is in partnership with York Press, RBL York Branch and the families of the three young men remembered in the Afghanistan Window in All Saints Pavement. We are hoping that people will embroider names on to the poppies of family members or friends who died or were injured in WW1 and all conflicts/wars since then to link WW1 with Afghanistan. http://www.yorkpress.co.uk/news/15634535.Spectacular_poppy_installation_planned_for_Armistice_centenary/
 More publicity will be done in Jan 2018 and continue through until Nov 2018.

4. We have researched the names of those who are commemorated on the memorial boards in our churches. This information will be made available for public viewing in our churches in 2018.

5. Plans are in place for the 2nd Annual Peace and Reconciliation Lecture in June 2018. We are hoping that Pastor Robert Pfeiffer and Pastor Annegret Wegner-Braun from Marienkirche in Lubeck, Germany will be with us to have dialogue.

6. Those named in the WW1 memorial book in St Martin Coney Street are being remembered by name in church services, on the anniversary of their death. This has been in place since 2014 and continues.

7. Holy Trinity Micklegate has educational information panels about WW1 on display in the church and joined in with the Micklegate businesses initiative to display wooden and knitted poppies along Micklegate.

8. We are planning Remembrance Day services or Acts of Remembrance for all of our churches to include silence at 11am on 11.11.18 and bell ringing that day to announce the 100th anniversary of the Armistice. The content for St Helen and St Martin will depend on the city's plans eg if a huge event is planned in the city centre.

9. We are planning services of music and readings in some of our churches on the eve of the Armistice (Sat night)

10. We are considering the use of All Saints Pavement Church for the 30 days during the Poppy Project installation. This could be in partnership with others to provide a programme of lectures, music, readings etc.

Other thoughts:-

a. I have been impressed in 2017 by the use of the words of in Flanders Fields which were marked out in poppies in several locations across the UK. Could something similar adorn the grassed areas of the walls of York?

b. I also wonder how the stories of local families can be told eg. the 10 Calpin brothers who went to war in WW1 <http://www.bbc.co.uk/news/av/uk-england-york-north-yorkshire-27622656/york-s-calpin-brothers-hailed-as-ww1-heroes>

c. Conversations with school are important and I haven't heard anything about what they might be planning. Could every school age child be given a memento of the 100th anniversary eg. a chocolate coin wrapped in a commemorative foil? (A real coin or medal would be better but I guess that's too expensive) Nestle might help.

d. I'm wondering whether or not York Minster has plans for the display of the Kings Book.

Finally, you might like to consider adding the following to your list of interested parties:-

York Press

BBC Radio York

That's tv York

Minster FM

Literature Festival - Rob O'Connor

Chocolate makers - Cocoa House, Nestle etc

- recalling Rowntree chocolates sent by the Lord Mayor, Joseph Rowntree

Local family history groups

War Graves Commission

All Ex-services Associations (might be covered by the Community Covenant)

Royal Dragoon Guards (All Saints Pavement is the Regimental Church)

Imphal Barracks

Padre Nia Williams based at 2 Signals Regiment

TA

Royal British Legion York Branch, including all the poppysellers (Denise Edgar is also a national RBL Trustee and can advise about copyright issues re the poppy symbol)

Festival of Remembrance Committee/Producer for the York Barbican event

Yorkshire Association of Change Ringers (YACR) - bellringers

NRM and York Station - because I feel that the WW1 was a war which took men away on trains and they didn't come back.

York Festival of Ideas - the theme for 2018 is Imagining the Impossible

Munster/Dijon twinning groups

Alliance Francaise

Breweries - a York 100th Armistice Anniversary ale?

I hope this helps.

With best wishes

Jane

Rev'd Jane Natrass

52 Bootham York YO30 7BZ

01904 623559 or 07568 530503 natrassjane@aol.com

Priest-in-Charge

York City Centre Churches

All Saints' Pavement, St Denys, St Helen, St Martin and St Olave,

Holy Trinity, Micklegate and St Lawrence

In a message dated 17/11/2017 15:44:12 GMT Standard Time, WW1Commemorations2018@york.gov.uk writes:

Dear Jane

As you will be aware, next year will see the 100 year anniversary since the end of World War I. The war saw horrifying loss and suffering and, whilst being called 'The war to end all wars', it of course proved to be far from that. Whilst all those that fought in the war have sadly now passed away and those who lived through it are now few in number, it is vital we continue to remember those that died in WW1 and those that have subsequently died in defence of our nation, and to educate people for the future. Next year's 100 year anniversary will be all the more poignant as it falls on a Sunday, although we are hoping that day will be just the culmination of a series of events across York.

Earlier this year, City of York's Council passed a motion calling for a Councillor group to be set up to co-ordinate plans for the commemoration across the city, with the aim of ensuring that as

Contradicting DORA - Ring for Peace

If you wander around the streets of York, you will find 3 mediaeval bells and an invitation to Ring for Peace. The locations are:-

1. Holy Trinity Goodramgate
2. The gardens of the Merchant Adventurers Hall
3. St Paul's Bookshop, Fossgate

The Defence Of the Realm Act forbade the ringing of some church bells during war time - this project asks people to ring a bell for peace to commemorate the 100th anniversary of WW1.

With permission of The York Bell Fund, three remaining bells from the old church of Holy Trinity or Christchurch (The Butchers' Church), King's Square have been located across the City for up to one year as we prepare a permanent home for the bells. We have details of the bells which indicate that they were founded by Chamberlain's of London circa 1440. These bells would have been heard by Saint Margaret Clitherow and by the butchers in the Shambles.



Rev'd Jane Nattrass is chaplain to the York Guild of Butchers who agreed to support the project. The link with Holy Trinity, Micklegate is apt because the Guild now meets in Jacob's Well, Holy Trinity, Micklegate's hall. Butchers were reserved occupations during wartime so it is pleasing that the Guild can be part of a peace bell project.



Aims:

- To enable the people of York to reclaim their connection with part of their heritage by telling the story of the bells and history to those who live here.
- To allow access to 15th century bells and bring them back into use.

- To assist in providing a City wide project which will be a legacy in the City of York commemorating the 100th anniversary of WW1.
- To bring back into use an empty bell tower for the benefit of the community and to engage with the heritage of York's only remaining priory church. It is hoped that the bells will find a permanent home in a church in York with three new bells. They will be known as York Peace Bells commemorating the 100th anniversary of WW1.

*The bells were founded by William Chamberlain c. 1440
each has a latin inscription:*

SANCTA MARGARETA ORA PRO NOBIS

Located St Paul's Bookshop
(St Margaret, pray for us)

SIT NOMEN DOMINI BENEDICTUM

Located at Holy Trinity Goodramgate
(Blessed be the name of the Lord)

ETERNIS ANNIS RESONET DOMINIS JOHANNES

Located at Merchant Adventurers Hall Gardens
(Through eternal years, let John resound for the Lord)

Thank you to Lucy Stewart of Stewart Architects Ltd, York Bell Fund, The Feoffees of St Michael Spurriergate, All Saints Pavement, Churches Conservations Trust at Holy Trinity Goodramgate, St Paul's bookshop and The Company of the Merchant Adventurers, The Gild of York Butchers, Guy Hanna-Clarke at Plowman Bros for the engineering, Kibby Schaefer at Matthias Garn for the oak signage.



From: Cllr. D. Carr
To: WW1Commemorations2018@york.gov.uk;
Subject: RE: Plans for the Commemoration of WW1 in York in 2018
Date: 20 November 2017 15:44:20

Dear Task Group

As a Copmanthorpe PC member, I shall be involved in the commemoration they're planning (presently a beacon to be lit in the village).

As to ideas for the Council's commemoration, one idea I suggest is a number of poetry readings (perhaps by different age groups) from the war poets, perhaps interspersed by a professional choir singing soldier songs like 'Tipperary' would go down well. Perhaps held in the Minster ?

If you're asking for participants, I would certainly like to have a spot and read out what I believe is an extraordinary war poem, and to explain why I think so.

Regards

David

Councillor David Carr

Leader, and Executive Member

for Finance and Performance

City of York Council

From: WW1Commemorations2018@york.gov.uk
Sent: 20 November 2017 12:21
To: CYC Conservative Group; CYC Green Group; CYC Labour Group; CYC Lib Dem Group; Cllr. M. Warters; Cllr. J. Hayes
Subject: Plans for the Commemoration of WW1 in York in 2018

Dear Members

As you will be aware, next year will see the 100 year anniversary since the end of World War I. The war saw horrifying loss and suffering and, whilst being called 'The war to end all wars', it of course proved to be far from that. Whilst all those that fought in the war have sadly now passed away and those who lived through it are now few in number, it is vital we continue to remember those that died in WW1 and those that have subsequently died in defence of our nation, and to educate people for the future. Next year's 100 year anniversary will be all the more poignant as it falls on a Sunday, although we are hoping that day will be just the culmination of a series of events across York.

Earlier this year, City of York's Council passed a motion calling for a Councillor group to be set up to co-ordinate plans for the commemoration across the city, with the aim of ensuring that as many people as possible feel part of the commemoration— see copy of motion attached.

<< File: Council Motion.doc >>

As the members of the Councillor group, we are keen to find out about:

- Any plans that you may already be involved in for developing a commemorative event;
- What the Council and its partners might be able to do to support those plans, and;
- What other ideas you might have for commemorative events or initiatives that you think the city might pursue

We are writing to a range of organisations and individuals – see copy of list attached.

<< File: Interested Parties.xls >>

We would be delighted to hear your thoughts and would welcome your feedback by email or, if there is demand we could soon set up a round table meeting for all interested parties. We would also welcome your suggestions for others we could write to.

From: [Steve Brown](#)
To: WW1Commemorations2018@york.gov.uk;
cc: [Sally Greenaway](#); [Kay Hyde](#); [Cllr. C. Steward](#); [Cllr. A. Mason](#);
[Cllr. D. Taylor](#); [Cllr. M. Wells](#);
Subject: Re: Commemoration of WW1 in York in 2018
Date: 21 November 2017 06:51:33

Dear Councillors,
Happy to get MIY involved with this.
I think a meeting of partners would be a good idea to kick things off.
Regards,

Steve

On 20 Nov 2017, at 15:07, WW1Commemorations2018@york.gov.uk wrote:

Hi Steve

This email is being sent to you to as MD of Make it York and as Co-ordinator for the Cultural Leaders Group.

As you will be aware, next year will see the 100 year anniversary since the end of World War I. The war saw horrifying loss and suffering and, whilst being called 'The war to end all wars', it of course proved to be far from that. Whilst all those that fought in the war have sadly now passed away and those who lived through it are now few in number, it is vital we continue to remember those that died in WW1 and those that have subsequently died in defence of our nation, and to educate people for the future. Next year's 100 year anniversary will be all the more poignant as it falls on a Sunday, although we are hoping that day will be just the culmination of a series of events

across York.

Earlier this year, City of York's Council passed a motion calling for a Councillor group to be set up to co-ordinate plans for the commemoration across the city, with the aim of ensuring that as many people as possible feel part of the commemoration— see copy of motion attached.

As the members of the Councillor group, we are keen to find out about:

- Any plans that you may already be developing for commemorative events;
- What the Council and its partners might be able to do to support those plans, and;
- What other ideas you might have for commemorative events or initiatives that you think the city might pursue

We are writing to a range of organisations and individuals, which includes the Members of the Cultural Leaders Group - see copy of list attached:

We would be delighted to hear your thoughts and would welcome your feedback by email or, if there is demand we could soon set up a round table meeting for all interested parties. We would also welcome your suggestions for others we could write to.

We look forward to hearing from you and would welcome your initial response by no

From: [Bond, Danielle](#)
To: WW1Commemorations2018@york.gov.uk;
cc: [Pollitt, Richard](#);
Subject: RE: Plans for WW1 Commemorations in York in 2018
Date: 21 November 2017 09:51:48

Good morning Melanie,

Thank you for getting in touch and I hope you are having a lovely weekend.

We are currently pushing for the festive preview opening and will be looking at our calendar for the next year later in December.

We will have a better idea of what we will be doing and we will be discussing the year ahead with the next Lord Mayor in January so it is difficult to say at this stage precisely what our plans are.

Please note our opening weekend is 2 & 3 December and then we have Christmas cheer receptions on 5 December so we are currently pressed for time.

Please see the contacts for the guilds below and we will endeavour to get back to you with ideas and thoughts for the year ahead before the deadline.

Guild of Building: steve.bielby@btopenworld.com

Guild of Scriveners: timjhinton@mypostoffice.co.uk

Company of Cordwainers:

davehobman@tiscali.co.uk

Guild of Freemen: thomasg624@aol.com

Company of Merchant Adventurers: the.clerk@theyorkcompany.co.uk

Company of Merchant Taylors:
clerk@merchant-taylors-york.org

Company of Butchers: jean@jjsawdon.co.uk

Guild of Media Arts: <https://www.guildofmediaarts.com/contact>

Apologies, we do not have a specific contact for the new guild, but that link should direct you to the right place.

Best wishes,
Danielle

From: WW1Commemorations2018@york.gov.uk

Sent: 20 November 2017 15:33

To: Wardle, Kirsty; Pollitt, Richard

Subject: Plans for WW1 Commemorations in York in 2018.

Hi Kirsty/Richard,

Kirsty - Please could you let me know what plans are in progress for the next Lord Mayor and Civic Party to participate in any WW1 Commemorations next year – see letter below that I am in the process of circulating to organisations and interested parties etc.

Richard – Can you let me know what plans you may have for the Mansion House to commemorate WW1 next year, and let me have the contact details for the

From: Williams, Fiona
To: WW1Commemorations2018@york.gov.uk;
cc: Croft, Charlie;
Subject: RE: Commemoration of WW1 in York in 2018
Date: 21 November 2017 14:15:17

Hi, we will send you our info. As we hold the Civic Archive, I was wondering whether councillors wanted to use any element of them in these commemorations? For instance, the council minutes from that time etc. It would be interesting to see how York celebrated the Armistice

We are planning to celebrate women's suffrage as well next year and the impact it had on York.

Fiona

From: WW1Commemorations2018@york.gov.uk
Sent: 20 November 2017 15:14
To: Williams, Fiona
Subject: Commemoration of WW1 in York in 2018

Hi Fiona,

As you will be aware, next year will see the 100 year anniversary since the end of World War I. The war saw horrifying loss and suffering and, whilst being called 'The war to end all wars', it of course proved to be far from that. Whilst all those that fought in the war have sadly now passed away and those who lived through it are now few in number, it is vital we continue to remember those that died in WW1 and those that have subsequently died in defence of our nation, and to educate people for the future. Next year's 100 year anniversary will be all the more poignant as it falls on a Sunday, although we are hoping that day will be just the culmination of a series of events across York.

Earlier this year, City of York's Council passed a motion calling for a Councillor Group to be set up to co-ordinate plans

for the commemoration across the city, with the aim of ensuring that as many people as possible feel part of the commemoration— see copy of motion attached.

<< File: Council Motion.doc >>

As the members of the Councillor Group, we are keen to find out about:

- Any plans that you may already be developing for commemorative events;
- What the Council and its partners might be able to do to support those plans, and;
- What other ideas you might have for commemorative events or initiatives that you think the city might pursue

We are writing to a range of organisations and individuals – see copy of list attached.

<< File: Interested Parties.xls >>

We would be delighted to hear your thoughts and would welcome your feedback by email or, if there is demand we could soon set up a round table meeting for all interested parties. We would also welcome your suggestions for others we could write to.

We look forward to hearing from you and would welcome your initial response by no later than Sunday 10th December 2017.

Yours sincerely

Cllr Ashley Mason

Cllr Chris Steward

From: [Delma Tomlin](#)
To: WW1Commemorations2018@york.gov.uk;
cc: Reyahn.King@ymt.org.uk; yarnactivitiesofficer@gmail.com;
director@yorkshireairmuseum.org; smaltby@yorkat.co.uk; esther@pilot-theatre.com; lizzierichards@theambassadors.com; mark.scott@yorkbarbican.co.uk; tony.c@picturehouses.co.uk; tom.bird@yorktheateroyal.co.uk; becky.thomson@yorktheateroyal.co.uk;
Subject: Re: Commemoration of WW1 in York in 2018
Date: 21 November 2017 16:49:44

Thank you - residing in a redundant church (St Margaret's Walmgate) & retaining a sense of responsibility for the parish, we have been commemorating the men who are listed on our Memorial Board in a series of events over the past 4 years and have outline plans for 11th November 2018 which I would be happy to share with you/ work alongside colleagues across the city. We are particularly interested in drawing together the history of the individuals listed and to commemorating their lives through music.

If you would like to meet to discuss joint publicity, I would be happy to do so

Best wishes. Delma Tomlin.
Director
National Centre for Early Music

Sent from my iPhone

On 20 Nov 2017, at 15:14, "WW1Commemorations2018@york.gov.uk" <WW1Commemorations2018@york.gov.uk> wrote:

As you will be aware, next year will see the 100 year anniversary since the end of World War I. The war saw horrifying loss and suffering and, whilst being called 'The war to end all wars', it of course proved to be far from that. Whilst all those that fought in the war have sadly now passed away and those who lived through it are now few in number, it is

vital we continue to remember those that died in WW1 and those that have subsequently died in defence of our nation, and to educate people for the future. Next year's 100 year anniversary will be all the more poignant as it falls on a Sunday, although we are hoping that day will be just the culmination of a series of events across York.

Earlier this year, City of York's Council passed a motion calling for a Councillor group to be set up to co-ordinate plans for the commemoration across the city, with the aim of ensuring that as many people as possible feel part of the commemoration— see copy of motion attached.

As the members of the Councillor group, we are keen to find out about:

- Any plans that you may already be developing for commemorative events;
- What the Council and its partners might be able to do to support those plans, and;
- What other ideas you might have for commemorative events or initiatives that you think the city might pursue

We are writing to a range of organisations and individuals – see copy of list attached.

We would be delighted to hear your thoughts and would welcome your feedback by email or, if there is demand we could soon set up a

From: Mark David Cosens
To: WW1Commemorations2018@york.gov.uk; Cllr. A. Mason;
Cllr. C. Steward; Cllr. D. Taylor; Cllr. M. Wells;
cc: Mark Taylor; Bill Kimberling; Richard Staples;
Subject: LDS WW1 Commemorations
Date: 22 November 2017 09:41:25

Dear Councillors,

Thank you, for your email about the WW1 events next year. This is really important and poignant. We are really looking forward to York putting on events that honour our fallen forebears and keep true to the principles defined in your brief.

Yes. The Church of Jesus Christ of Latter-day Saints is planning a nationwide series of significant public, commemorative events including for York.

You may remember 'The Christmas Truce' event held in 2014 to mark the famous WW1 football match ...

<https://m.youtube.com/watch?v=LXnV-z-Hxk> ...

This combined a centrally-produced, high quality, video and musical presentation; with local histories brought to life via readings and displays. There was a theatrical set built to model the trenches and a choir dressed in replica WW1 uniforms. We hosted The Civic Party, MPs and faith, community and civic leaders and there were approximately 700 in attendance in York.

For 2018 we are planning a comparable event, probably titled 'The Fallen' (TBC). The details of this are due to be released imminently and I will send them on to you as soon as they are.

May I just clarify in relation to the 'interested parties' list that you have: I am able to help for The Church of Jesus Christ of Latter-day Saints and York Interfaith Group. However, it is Richard Staples (CC'd and also of BBC Radio York) who looks after the Friday Mailing to the York churches (Christians in Communication).

Thank you again, for these preparations and your email.

I will let you know as soon as our plans are published.

Sincerely,

Mark Cosens
Regional Director for Public Affairs

The Church of Jesus Christ of Latter-day Saints
07796095152

Sent from my iPhone

From: Jo Wright
To: WW1Commemorations2018@york.gov.uk;
Subject: Re: Plans for WW1 Commemorations in York in 2018
Date: 23 November 2017 09:00:55

Dear Steve

Provisionally the Merchant Taylors will wish to participate in some capacity. I am currently out of the country and will reply more fully when I return in December.

Kind regards

Jo

Jo Wright
Clerk

Get Outlook for IOS

From: WW1Commemorations2018@york.gov.uk <WW1Commemorations2018@york.gov.uk>
Sent: Tuesday, November 21, 2017 3:41:33 PM
To: 'steve.bielby@btopenworld.com'; 'timjhinton@mypostoffice.co.uk'; 'davehobman@tiscali.co.uk'; 'thomasg624@aol.com'; 'the.clerk@theyorkcompany.co.uk'; 'clerk@merchant-taylors-york.org'; 'jean@jjsawdon.co.uk'; 'everyone@guildofmediaarts.com'
Subject: Plans for WW1 Commemorations in York in 2018

Dear Guilds,

As you will be aware, next year will see the 100 year anniversary since the end of World War I. The war saw horrifying loss and suffering and, whilst being called 'The war to end all wars', it of course proved to be far from that. Whilst all those that fought in the war have sadly now passed away and those who lived through it are now few in number, it is vital we continue to remember those that died in WW1 and those that have subsequently died in defence of our nation, and to educate people for the future. Next year's 100 year anniversary will be all the more poignant as it falls on a Sunday, although we are hoping that day will be just the culmination of a series of events across York.

Earlier this year, City of York's Council passed a motion calling for a Councillor group to be set up to co-ordinate plans for the commemoration across the city, with the aim of ensuring that as many people as possible feel part of the commemoration— see copy of motion attached.

As the members of the Councillor group, we are keen to find out about:

- . Any plans that you may already be developing to commemorate the WW1 centenary;
- . What the Council and its partners might be able to do to support those plans, and;
- . What other ideas you might have for commemorative events or initiatives that you think the city might pursue
- . Whether you would be willing to participate in any events being organised in the city

We are writing to a range of organisations and individuals – see copy of list attached.

We would be delighted to hear your thoughts and would welcome your feedback by email or, if there is demand we could soon set up a round table meeting for all interested parties. We would also welcome your suggestions for others we could write to.

We look forward to hearing from you and would welcome your initial response by no later than Sunday 10th December 2017.

Yours sincerely

Cllr Ashley Mason
Cllr Chris Steward
Cllr Dave Taylor
Cllr Margaret Wells
(WW1 Commemorations 2018 City of York Council Task Group)



Help protect the environment! - please don't print this email unless you really need to.

This communication is from City of York Council.

The information contained within, and in any attachment(s), is confidential and legally privileged. It is for the exclusive use of the intended recipient(s). If you are not the intended recipient(s), please note that any form of distribution, copying or use of this communication, or the information within, is strictly prohibited and may be unlawful. Equally, you must not disclose all, or part, of its contents to any other person.

If you have received this communication in error, please return it immediately to the sender, then delete and destroy any copies of it.

City of York Council disclaims any liability for action taken in reliance on the content of this communication.

City of York Council respects your privacy. For more information on how we use your personal data, please visit <http://www.york.gov.uk/privacy>

From: Carole Green
To: WW1Commemorations2018@york.gov.uk; Stewart;
Ian George;
Subject: Nov 2018
Date: 24 November 2017 10:18:42

Bishopthorpe PC has plans well in hand for the commemoration but would be interested to know what is planned for the city as a whole.
please add this e mail address to your list.
thank you
Carole Green (parish Councillor)

From: [Carole Green](#)
To: WW1Commemorations2018@york.gov.uk
Subject: Re: Nov 2018
Date: 27 November 2017 17:05:29
Attachments: [Image001.png](#)

good evening Melanie

we hope to involve as many families in the village as possible and to that extent we are liaising with the Junior school to hold the event there.

It will be on Sunday 11 Nov -probably starting around 16.30 so as to be able to include families with young children

We plan to have a brazier but one made locally and at the moment it looks as if we might be lighting earlier than the 19.00 suggested nationally However it will still be burning at that time.

A villager has just brought out a book of Bishopthorpe's war heroes so that will be the basis of the commemoration and we are researching the food that was served at the street party in 1919 to see how much can be replicated.

We will invite Bishopthorpe's choir plus the school 'musicality' group to lead everyone in singing a few songs from WWI.

that's it so far

best

Carole Green

From: "WW1Commemorations2018@york.gov.uk" <WW1Commemorations2018@york.gov.uk>
To: 'Carole Green' <linkeditor48@yahoo.co.uk>
Sent: Monday, 27 November 2017, 11:59
Subject: RE: Nov 2018

Hi Carole

Thank you for your response below. We would be grateful if you could give us an outline of what your plans are?

Regards

Melanie

Melanie Carr | Scrutiny Officer
t: 01904 552054 | e: melanie.carr@york.gov.uk

City of York Council | Scrutiny Services
Room F031| 1st Floor | West Offices | York YO1 6GA
www.york.gov.uk | facebook.com/cityofyork | @CityofYork



Working together, to improve and make a difference

From: Carole Green [<mailto:linkeditor48@yahoo.co.uk>]
Sent: 24 November 2017 10:19

To: WW1Commemorations2018@york.gov.uk; Stewart; Ian George
Subject: Nov 2018

Bishopthorpe PC has plans well in hand for the commemoration but would be interested to know what is planned for the city as a whole.
please add this e mail address to your list.
thank you

Carole Green (parish Councillor)

Help protect the environment! - please don't print this email unless you really need to.

This communication is from City of York Council.

The information contained within, and in any attachment(s), is confidential and legally privileged. It is for the exclusive use of the intended recipient(s). If you are not the intended recipient(s), please note that any form of distribution, copying or use of this communication, or the information within, is strictly prohibited and may be unlawful. Equally, you must not disclose all, or part, of its contents to any other person.

If you have received this communication in error, please return it immediately to the sender, then delete and destroy any copies of it.

City of York Council disclaims any liability for action taken in reliance on the content of this communication.

City of York Council respects your privacy. For more information on how we use your personal data, please visit <http://www.york.gov.uk/privacy>

From: Graeme Thomas
To: WW1Commemorations2018@york.gov.uk;
cc: Cllr. J. Hayes; Cllr. L. Kramm; Cllr. J. Crawshaw;
Subject: Contribution to York Council's gathering of plans on WW1 commemoration in 2018.
Date: 25 November 2017 14:31:27

For the attention of Councillor Dave Taylor and colleagues.

In the recent 'Friday Mailing' it was reported that you had requested details of any contributions within the local community for plans to commemorative WW1 commemorations in 2018. Our planned contribution is:

1. Morning service and a memorial commemoration service in the interior of St Marys Bishophill Junior, from 9.15am on Sunday 11 November. The morning service and commemoration at the internal war memorial will be open to the general public.
2. St Mary's Bishophill Junior in Central York, the Bishophill History Group and The Heritage Singers are in discussions to produce a WW1 commemorative concert at St Marys on the evening of Sunday November 11, 2018. The current plan is for a concert of appropriate choral music interspersed with poetry and readings recalling lives of citizens who were members of our community and within Central York before or during WW1. The concert will be open to the general public.

Graeme Thomas
Churchwarden St. Marys Bishophill Junior
and Vice-Chair Bishophill History Group.
01904 610389/07905 248126
graemegthomas@aim.com

Sent from my iPad

From: [Steve Galloway](mailto:Steve.Galloway)
To: WW1Commemorations2018@york.gov.uk;
Subject: RE: Plans for WW1 Commemorations in York in 2018
Date: 26 November 2017 16:08:25

We think that you should do two things

1. Survey all war memorials and war graves (York cemetery) and confirm that they are all in good condition. If necessary launch a crowd funding appeal and get them cleaned up, repointed etc.
2. Agree on a theme for memorial day and ask Parish councils, Councillors,, Residents Associations, voluntary organisations and individuals to organise something against the theme. For example this might be to fund public seats with a dedication, build a public poppy bed etc. Offer matching funding for approved schemes.

Steve

From: WW1Commemorations2018@york.gov.uk [mailto:WW1Commemorations2018@york.gov.uk]
Sent: 17 November 2017 16:38
To: 'brianjewatson42@aol.co.uk' <brianjewatson42@aol.co.uk>; 'chashall@btinternet.com' <chashall@btinternet.com>; 'ddahortonmbe@gmail.com' <ddahortonmbe@gmail.com>; 'wilde-d@sky.com' <wilde-d@sky.com>; 'irene.waudby@gmail.com' <irene.waudby@gmail.com>; 'jpmorley@hotmail.co.uk' <jpmorley@hotmail.co.uk>; 'admin@ascothouseyork.com' <admin@ascothouseyork.com>; 'kenking401@gmail.com' <kenking401@gmail.com>; 'kirkyork@aol.com' <kirkyork@aol.com>; 'mikecathy53@gmail.com' <mikecathy53@gmail.com>; 'rayfcarr@hotmail.co.uk' <rayfcarr@hotmail.co.uk>; 'r.watson@crombiewilkinson.co.uk' <r.watson@crombiewilkinson.co.uk>; 'steve.galloway@btinternet.com' <steve.galloway@btinternet.com>; 'susan.galloway@btinternet.com' <susan.galloway@btinternet.com>
Subject: Plans for WW1 Commemorations in York in 2018

Dear Alderman,

As you will be aware, next year will see the 100 year anniversary since the end of World War I. The war saw horrifying loss and suffering and, whilst being called 'The war to end all wars', it of course proved to be far from that. Whilst all those that fought in the war have sadly now passed away and those who lived through it are now few in number, it is vital we continue to remember those that died in WW1 and those that have subsequently died in defence of our nation, and to educate people for the future. Next year's 100 year anniversary will

be all the more poignant as it falls on a Sunday, although we are hoping that day will be just the culmination of a series of events across York.

Earlier this year, City of York's Council passed a motion calling for a Councillor group to be set up to co-ordinate plans for the commemoration across the city, with the aim of ensuring that as many people as possible feel part of the commemoration— see copy of motion attached.

As the members of the Councillor group, we are keen to find out about:

- Any plans that you may already be developing for commemorative events;
- What the Council and its partners might be able to do to support those plans, and;
- What other ideas you might have for commemorative events or initiatives that you think the city might pursue

We are writing to a range of organisations and individuals – see copy of list attached.

We would be delighted to hear your thoughts and would welcome your feedback by email or, if there is demand we could soon set up a round table meeting for all interested parties.

We look forward to hearing from you and would welcome your initial response by no later than Sunday 10th December 2017.

Yours sincerely

Cllr Ashley Mason

Cllr Chris Steward

Cllr Dave Taylor

Cllr Margaret Wells

(WW1 Commemorations 2018 City of York Council Task Group)

From: [Sara Mason](#)
To: WW1Commemorations2018@york.gov.uk
Subject: Askham Richard
Date: 27 November 2017 16:55:46

Askham Richard Parish Council are organising a beacon, hopefully on the village green, as part of the commemorations organised by Bruno Peek and his nationwide "Battle's Over – A Nation's Tribute" events. We were contacted about this several months ago.

If you would like any further information or contact details then please let me know.

Sara Mason
Chair, Askham Richard Parish Council
The Winnowing House, Mill Lane, Askham Richard, York, YO23 3NW
01904 703060 / 07711 952262

From: Bridget Morris
To: WW1Commemorations2018@york.gov.uk;
Subject: Lawrence Rowntree KIA
Date: 01 December 2017 09:07:01

Good morning

I saw your piece in Christians in Communication this morning.

I'm not sure whether it's relevant to your plans, but we have an exhibition in the Community Room at York Castle Museum on 'Lawrence Rowntree - a soldier of the Great War' who was killed in action at Passchendaele on 25 November 1917. He was Joseph Rowntree's grandson.

We've done a short film on his brief life, see <https://www.youtube.com/watch?v=5ULHEkLc9kU>

Kind regards
Bridget

Bridget Morris
Executive Director, The Rowntree Society
tel. 01904 543384

Clements Hall
Nunthorpe Road
York YO23 1BW

www.rowntreesociety.org.uk
[Twitter @rowntreesoc](https://twitter.com/rowntreesoc)

*In 2017 launching a
book of Five Rowntree
Walks in York
spotlighting Lawrence
Rowntree, who
was killed in action at
the battle of
Passchendaele.*

and

From: Dawn Hallaways
To: WW1Commemorations2018@york.gov.uk;
Subject: RE: Commemoration of WW1 in York in 2018
Date: 04 December 2017 11:42:42

Good Morning

I can confirm that York St John University is not, at the current time, planning any specific commemoration events for WW1 next year. At our Graduation ceremonies in November, we did award a posthumous Honorary Fellowship to one of our students, John 'Jack' Harrison, who lost his life fighting in WW1, to mark the centenary of his death at Oppy Wood in 1917. However, York St John is of course happy to be involved in and support any city-wide events that might be held throughout next year.

Best wishes.

Dawn Hallaways
Executive Officer to the Vice Chancellor
York St John University
01901 876601

From: WW1Commemorations2018@york.gov.uk [mailto:WW1Commemorations2018@york.gov.uk]
Sent: 20 November 2017 15:13
To: Dawn Hallaways; 'vc@york.ac.uk'; 'joan.concannon@york.ac.uk'
Subject: Commemoration of WW1 in York in 2018

As you will be aware, next year will see the 100 year anniversary since the end of World War I. The war saw horrifying loss and suffering and, whilst being called 'The war to end all wars', it of course proved to be far from that. Whilst all those that fought in the war have sadly now passed away and those who lived through it are now few in number, it is vital we continue to remember those that died in WW1 and those that have subsequently died in defence of our nation, and to educate people for the future. Next year's 100 year anniversary will be all the more poignant as it falls on a Sunday, although we are hoping that day will be just the culmination of a series of events across York.

Earlier this year, City of York's Council passed a motion calling for a Councillor Group to be set up to co-ordinate plans for the commemoration across the city, with the aim of ensuring that as many people as possible feel part of the commemoration— see copy of motion attached.

As the members of the Councillor Group, we are keen to find out about:

- Any plans that you may already be developing for commemorative events;
- What the Council and its partners might be able to do to support those plans, and;
- What other ideas you might have for commemorative events or initiatives that you think the city might pursue

We are writing to a range of organisations and individuals – see copy of list attached.

We would be delighted to hear your thoughts and would welcome your feedback by email or, if there is demand we could soon set up a round table meeting for all interested parties. We would also welcome your suggestions for others we could write to.

We look forward to hearing from you and would welcome your initial response by no later than Sunday 10th December 2017.

Yours sincerely

Cllr Ashley Mason

Cllr Chris Steward
Cllr Dave Taylor
Cllr Margaret Wells
 (VW1 Commemorations 2018 City of York Council Task Group)



 Help protect the environment! - please don't print this email unless you really need to.

This communication is from City of York Council.

The information contained within, and in any attachment(s), is confidential and legally privileged. It is for the exclusive use of the intended recipient(s). If you are not the intended recipient(s), please note that any form of distribution, copying or use of this communication, or the information within, is strictly prohibited and may be unlawful. Equally, you must not disclose all, or part, of its contents to any other person.

If you have received this communication in error, please return it immediately to the sender, then delete and destroy any copies of it.

City of York Council disclaims any liability for action taken in reliance on the content of this communication.

City of York Council respects your privacy. For more information on how we use your personal data, please visit <http://www.york.gov.uk/privacy>



This email and any files transmitted with it were intended solely for the addressee. If you have received this email in error please let the sender know by return.

Please think before you print.

From: Stuart Robson
To: WW1Commemorations2018@york.gov.
uk;
cc: "Anne";
Subject: CELEBRATION OF ARMISTICE 1918
Date: 04 December 2017 12:58:12

Dear Committee,

Thank you for your invitation to supply info. re any planned events for 1918-2018.

Upper and Nether Poppleton Parish Councils have united to plan an event on November 11th 2018 on the Village Green , Upper Poppleton in the early evening probably 6.00pm but time yet to be confirmed.

There will be a band, bugeler for Las Post and Reveille, choir, readings with both All Saints Church and Poppleton Methodist church personnel involved, around a brazier on a 7 foot post.

Refreshments will be provided following the service.

Further details to be confirmed in the New Year.

Stuart Robson
Chairman of Upper Poppleton Parish Council.

From: THOMASG624@aol.com
To: WW1Commemorations2018@york.gov.uk;
Subject: Re: Plans for WW1 Commemorations in York in 2018
Date: 07 December 2017 12:34:54.

Dear Councillors,

I raised this at a the court meeting of the Gild of Freemen of the City of York last night, whilst we have no particular plans for a gild event at the moment we are more than happy to participate in any events held. However knowing our court members they may well come up with an idea for something we can organise. We also understand that this is to be raised at the Clerks meeting of all the Guilds on the 13th of the month and I shall be suggesting that all the Guilds might get together to host an event. I realise this is after the deadline for expressions of initial interest, I hope this will not prevent any idea for an event being included.

We look forward to hearing more about what is planned for the year.

Best wishes

Tom

T.Gibson.

Mr. Tom Gibson, Clerk to and Past Master of the Gild of Freemen of York

<http://www.freemenofyork.com/> <https://www.facebook.com/groups/freemenyork/>

Chairman of York Strays Council,

Pasture Master of Monk Stray

Hon. Editor of the Journal of the Association of the Freemen of England and Wales.

<http://www.freemenfew.org.uk/Default.aspx> <https://www.facebook.com/FreemenOfEnglandWales>

Admin of the York World Heritage bid facebook page.

<https://www.facebook.com/YorkWorldHeritage?ref=hl>

Supporting the York Waggon Plays 2018. <http://www.yorkmysteryplays.co.uk/>

<https://www.facebook.com/MysteryPlaysYork>

In a message dated 11/21/2017 1:41:40 P.M., GMTStandard Time, WW1Commemorations2018@york.gov.uk writes:

Dear Guilds,

As you will be aware, next year will see the 100 year anniversary since the end of World War I. The war saw horrifying loss and suffering and, whilst being called 'The war to end all wars', it of course proved to be far from that. Whilst all those that fought in the war have sadly now passed away and those who lived through it are now few in number, it is vital we continue to remember those that died in WW1 and those that have subsequently died in defence of our nation, and to educate people for the future. Next year's 100 year anniversary will be all the more poignant as it falls on a Sunday, although we are hoping that day will be just the culmination of a series of events across York.

Earlier this year, City of York's Council passed a motion calling for a Councillor group to be set up to co-ordinate plans for the commemoration across the city, with the aim of ensuring that as many people as possible feel part of the commemoration— see copy of motion attached.

As the members of the Councillor group, we are keen to find out about:

- . Any plans that you may already be developing to commemorate the WW1 centenary;
- . What the Council and its partners might be able to do to support those plans, and;
- . What other ideas you might have for commemorative events or initiatives that you think the city might pursue
- . Whether you would be willing to participate in any events being organised in the city

We are writing to a range of organisations and individuals – see copy of list

attached.

We would be delighted to hear your thoughts and would welcome your feedback by email or, if there is demand we could soon set up a round table meeting for all interested parties. We would also welcome your suggestions for others we could write to.

We look forward to hearing from you and would welcome your initial response by no later than Sunday 10th December 2017.

Yours sincerely

Cllr Ashley Mason
Cllr Chris Steward
Cllr Dave Taylor
Cllr Margaret Wells
(WW1 Commemorations 2018 City of York Council Task Group)



Help protect the environment! - please don't print this email unless you really need to.

This communication is from City of York Council.

The information contained within, and in any attachment(s), is confidential and legally privileged. It is for the exclusive use of the intended recipient(s). If you are not the intended recipient(s), please note that any form of distribution, copying or use of this communication, or the information within, is strictly prohibited and may be unlawful. Equally, you must not disclose all, or part, of its contents to any other person.

If you have received this communication in error, please return it immediately to the sender, then delete and destroy any copies of it.

City of York Council disclaims any liability for action taken in reliance on the content of this communication.

City of York Council respects your privacy. For more information on how we use your personal data, please visit <http://www.york.gov.uk/privacy>

From: juliaskitt@mail.com
To: WW1Commemorations2018@york.gov.uk;
vicar@stgileschurchcopmanthorpe.org;
Subject: Commemoration of 100 years since the end of World War 1
Date: 09 December 2017 16:35:18

Dear Cllrs., Ashley Mason, Chris Steward, Dave Taylor and Margaret Wells

I was recently forwarded your email from one of the members of the Anglican Church Congregation in Copmanthorpe and wonder whether you have been in touch with other churches in the area as they are all normally very mindful of Remembrance Sunday, and will be even more so, next year.

Every year in Copmanthorpe, St.Giles Parish Church, in partnership with Copmanthorpe Methodist Church, hold a remembrance service on the village green to which some 300/500 villagers attend as well as around 300 youngsters in our very strong village uniformed organisations.

We will be planning a much more focussed Remembrance Sunday next year in conjunction with the leaders of the uniformed organisations.

Already ladies in the village are knitting poppies to make a massive display.

We have a joint mission group and there will be a separate group to organise other events throughout the year as well as community initiatives. The Methodist Circuit is also putting in place events at key points too, as their are Connexional projects in hand that we will be asked to take part in. The wider Anglican Church too will have a number of opportunities.

I have included Reverend Geoff Mumford in this email, Vicar of Askham Bryan, Bolton Percy with Colton and Copmanthorpe and Rural Dean of New Ainsty. We would be interested to hear about the initiatives you are planning, and happy for you to add us to your mailing list.

Reverend Julia Skitt
Minister for Acaster Malbis, Bishopthorpe, Copmanthorpe and
Stillingfleet Methodist Churches
1 Dykes Lane, Copmanthorpe, York YO23 3YT
landline: 01904 709713 mobile: 07810360778

From: Allison Freeman
To: WW1Commemorations2018@york.gov.
 uk,
Subject: WW1 Commemorations 2018
Date: 10 December 2017 17:54:53
Attachments: Battles-Over-Guide-April-2017.pdf

Thank-you for your email regarding WW1 Commemorations in 2018. We would be keen to work with other groups and organisations across the city with regard to WW1 Commemorations in 2018, and would be happy to attend any round table meetings if required.

The York Army Museum current plans for commemoration include a new HLF funded project
Impact: First World War
Legacies, details below:

The York Army Museum has recently received £6300 from the Heritage Lottery Fund for an exciting new project,
Impact: First World War
Legacies, through HLF's First World War: Then and Now programme. The project will focus on exploring the experiences of Yorkshire soldiers when returning home to Yorkshire, and the efforts made to memorialise those who did not. This project involves discussion of soldiers' return to the UK and will work to support school and community groups explore war memorials in their areas, and research soldiers appearing on them. The project will result in greater awareness and understanding of the diversity of those who fought in the First World War and how the conflict affected the local area after its conclusion. We are offering free workshops and resources to local school and community groups to help document war memorials that are housed within buildings and areas they use. The outcomes of this project will be a temporary exhibition hosted at York Army Museum and a database compiling information regarding the local war memorials documented and the soldiers who are documented on them. The information generated on this database will be available through the exhibition and also in the archive and via the website of York Army Museum.

We will also have a programme of talks and activities throughout the year.

Other Suggestions

1. One thing which might prove useful would be a central website or printed leaflet which draws together key details of the various events planned across the city. We have approached the Minster, Mansion House, NRM and Bar Convent about liaising to produce joint information aimed at schools and youth groups which simply gives details of the themes/topics in relation to WW1 which each organisation is concentrating on during 2018 so it is helpful for teachers' planning and information purposes, perhaps something like that would be useful but on a bigger scale.

2. We hosted a Memorabilia Roadshow last year where we invited the public to bring along photographs, documents, medals etc and we would help them with identifying and finding out more about their documents. We worked with Explore York Archives and are planning to do so again next year with a world war 1 focus. Such an event with an emphasis on WW1 history could allow people across the city to share stories, learn how to look after their documents and artefacts and create a community led exhibition which could be displayed at various venues across the city.

I have attached a pdf we received at the museum from the pageantmaster about national beacon lighting commemorations on November 11 2018 in case it is useful, although you will probably have seen it already.

Best wishes

Allison Freeman
 Learning & Engagement Officer
 York Army Museum

01904 461016

Sent: 21 November 2017 14:02
To: 'info@yorkarmymuseum.co.uk' <info@yorkarmymuseum.co.uk>
Subject: Plans for WW1 Commemorations in York in 2018

As you will be aware, next year will see the 100 year anniversary since the end of World War I. The war saw horrifying loss and suffering and, whilst being called 'The war to end all wars', it of course proved to be far from that. Whilst all those that fought in the war have sadly now passed away and those who lived through it are now few in number, it is vital we continue to remember those that died in WW1 and those that have subsequently died in defence of our nation, and to educate people for the future. Next year's 100 year anniversary will be all the more poignant as it falls on a Sunday, although we are hoping that day will be just the culmination of a series of events across York.

Earlier this year, City of York's Council passed a motion calling for a Councillor group to be set up to co-ordinate plans for the commemoration across the city, with the aim of ensuring that as many people as possible feel part of the commemoration— see copy of motion attached.

As the members of the Councillor group, we are keen to find out about:

- Any plans that you may already be developing for commemorative events;
- What the Council and its partners might be able to do to support those plans, and;
- What other ideas you might have for commemorative events or initiatives that you think the city might pursue

We are writing to a range of organisations and individuals – see copy of list attached.

We would be delighted to hear your thoughts and would welcome your feedback by email or, if there is demand we could soon set up a round table meeting for all interested parties. We would also welcome your suggestions for others we could write to.

We look forward to hearing from you and would welcome your initial response by no later than Sunday 10th December 2017.

BATTLE'S OVER



A NATION'S TRIBUTE

11TH NOVEMBER 2018

100 YEARS OF REMEMBRANCE

WW1 Beacons of Light 11th November 2018

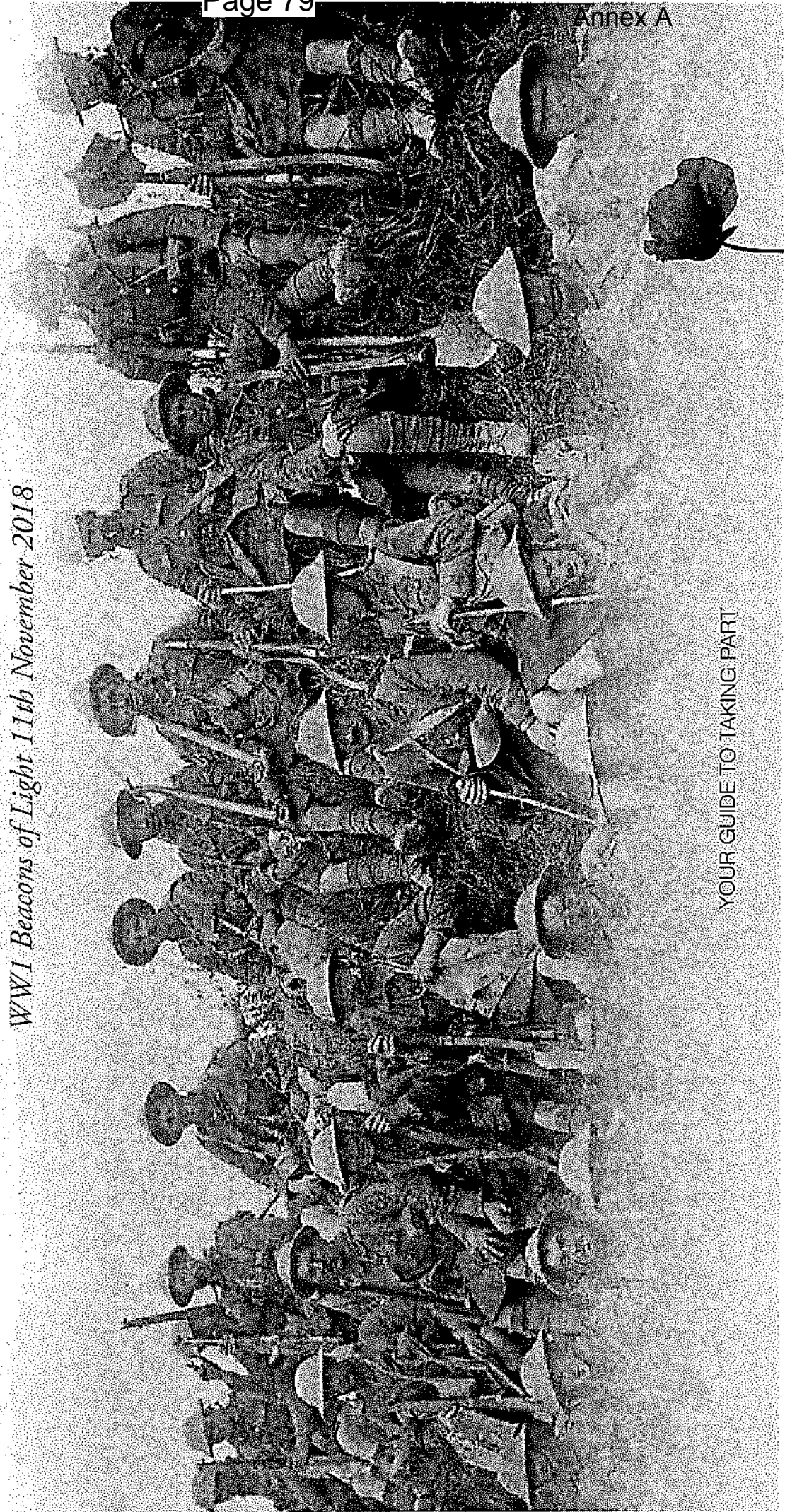

YOUR GUIDE TO TAKING PART

Introduction

On 3rd August 1914, Britain's Foreign Minister, Sir Edward Grey, was looking out of his office window. It was dusk, and the gas lights were being lit along London's Mall, leading to Buckingham Palace, when he remarked to a friend, "The lamps are going out all over Europe; we shall not see them lit again in our lifetime." Our country was about to be plunged into the darkness of the First World War, and it would be four long years before Britain and Europe would again experience the light of peace.

In commemoration and remembrance of the end of the war and the many millions who were killed or came home dreadfully wounded, 1000 Beacons of Light will be lit at 7pm on 11th November 2018 throughout the United Kingdom, Channel Islands, Isle of Man and UK Overseas Territories - a century after the guns fell silent. The event will also commemorate the huge army of men and women on the home front who, often in dangerous and exhausting conditions, underpinned the war effort - keeping the wheels of industry turning, bringing the harvests home to ensure the nation did not starve.

The Beacons will symbolise the 'light of hope' that emerged from the darkness of war. You will be pleased to know that to date more than 800 councils, communities and other organisations have already confirmed their involvement by lighting WWI Beacons of Light that evening. (Please see acknowledgements on pages 12-19. These pages will be updated every three months up to 31st October 2018).

For example, beacons are being lit at the Tan Hill Inn, Yorkshire Dales, the highest pub in Great Britain; on the island of Unst, the most northerly inhabited island in Scotland; St Davids, the most westerly City in Wales; Lowestoft, Suffolk, the most easterly town in England, and at St Macartin's Cathedral, Enniskillen, the most westerly location in the United Kingdom. We do hope that your council and community will link with the other 800 (to date) and take part in this unique, historic tribute.

There are a number of cost-effective ways of participating in this event.

**BATTLE'S
OVER**



A NATION'S TRIBUTE
11TH NOVEMBER 2018
100 YEARS OF REMEMBRANCE

*Your chance to pay your
personal and community*

tribute to those millions

that gave their lives

for their country

during the dreadful darkness

of four years of War

1914 - 1918

100 YEARS OF REMEMBRANCE

(1) Use existing Beacon Braziers set on tall wooden poles and gas fuelled beacons previously purchased for other historic anniversaries, celebrations and commemorations.

Build and light a traditional Bonfire Beacon.

(3) You may wish to purchase the special gas-fuelled beacon being produced for this project as, once used, it can be stored away for the future and then used for other such beacon occasions making it more economic - please see page 4.

(4) Build and erect a new Beacon Brazier on a tall wooden pole, using it as a permanent tribute to those that lost their lives in your local community during World War I - see page 5. (You may need to apply for planning permission so please contact your Local Authority Planning Department seeking their advice).

Those councils and organisations taking part will be able to download a special certificate after the event as a permanent reminder of their involvement in this tribute. (Details of where to obtain it will be sent in the latter part of November 2018).

Please see page 3 for how to participate.

As you will see from pages 8, 9, 10 and 11 we have four very worthy and appropriate charities associated with this event, representing The Royal Navy, Royal Air Force, Army and Merchant Navy, so please feel free to make charitable donations direct to one or more of them. (You may also wish to consider staging a public collection for them around the lighting of your Beacon on 11th November 2018).

I look forward to hearing from you in due course.



Bruno Peek

Bruno Peek LVO OBE OPR
Pageantmaster
Battle's Over - A Nation's Tribute
& WWI Beacons of Light



How to take part & Beacon Lighting Ceremony

How to take part

Step 1: To confirm your involvement and assist us in easy communication and correct registration of your event, please be kind enough to undertake the following in FULL as soon as possible, sending it to Bruno Peek LVGOBEOPR, Pageantmaster, Battle's Over - A Nation's Tribute & WW1 Beacons of Light at - brunopeek@mac.com

If your event is a private occasion and NOT open to the public, and you do not want your involvement shown on any public or media listing, it is important that you confirm this when providing information requested below. Your participation will still be noted as part of this historic occasion but NOT made public.

However, if your event is open to the public your contact details will be shared with the media so that they can contact you direct to arrange any publicity and/or coverage of your event on 11th November 2018.

Name of Contact/Coordinator

Name of Council or Organisation:

Job title of Coordinator

Full postal address including postcode

County

Country: England, Wales, Scotland, Northern Ireland, Channel

Islands, Isle of Man, UK Overseas Territory

Telephone number - landline

Mobile number

Email Address

Beacon Location if known when registering, including postcode

Please ensure you have undertaken all the safety aspects etc, outlined on page 6 and before the lighting of your Bonfire Beacon on page 5 and you have alerted the emergency services, including the Fire Brigade, undertaken any risk assessments required and ensure all are happy with your plans. (This is your responsibility as coordinator of your Beacon lighting event).

Beacon Lighting Ceremony - 7pm on 11th November 2018

The Beacon lighting ceremony should be undertaken as follows:

Step 2: Invite your Lord Lieutenant, DL, Lord Mayor, Mayor, High Sheriff, High Steward, Lord Provost, Chairman or Leader of the Council. However, you may wish to consider running a competition in partnership with your local media, with the winner having the honour of lighting your WW1 Beacon of Light at 7pm that evening.

Step 3: Please arrange to have professional photographs taken during your event, and immediately after, please send NO more than TWO high quality, copyright-free photographs to brunopeek@mac.com including the name of the photographer, the Beacon location, including postcode, along with the name of the Council or Organisation.

Step 4: If appropriate, please use social media channels - Twitter, Facebook etc - to promote your event. On Facebook, post photographs of your Beacon lighting ceremony on the 11th November 2018.

Step 5: On 1st November 2018 we will be providing you with an outline Press Release for

your use, so please localise it, providing as much or as little information as you wish regarding your event, along with your contact details before YOU send it to all areas of your local media to enable them to contact YOU direct.

Step 6: Before the lighting of your Beacon at 7pm you may wish to consider reading out the names of those from your your City, Town or Parish etc killed in action, during WW1, in remembrance of the sacrifices made.

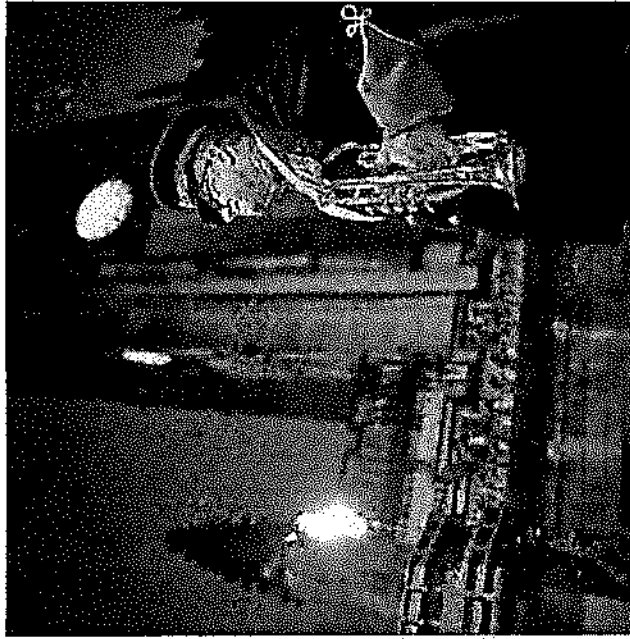

Bonfire Beacon, Killybegs, County Down, Northern Ireland.



Beacon at Manor Farm, Silets, Devon, courtesy of Kate Gill, Silets Parish Council.



WWI Beacons of Light, your unique gas-fuelled Beacon

The Battle's Over Beacon is of lightweight construction and comes assembled and complete with the exception of the gas cylinders that will need to be purchased separately:

- 400g disposable cylinder of propane, (Bullfinch No 1644, or equivalent) for the FirePower Torch used to light the Beacon. These can be purchased from many DIY stores or Builders Merchants.
- One full 47 kg propane cylinder or 2 x 19 kg full cylinders are recommended to give a full flame for an hour. For longer periods of burning or with partially full cylinders you will need double the number of cylinders. These cylinders can be purchased from Flogas Britain Ltd by calling 0800 085 6225 quoting Gas-Fuelled Beacons or by going to their website www.flogas.co.uk where you can either order your cylinder online or locate your nearest Flogas stockist. You may also download a propane cylinder safety data sheet from the Flogas website (www.flogas.co.uk/safety).



The Gas-Fuelled Beacon package will contain the following:

- Burner unit with distinct design to commemorate the event - with the motif WWI 1914, 18 round the circumference
- 2m high stand with an anchor for fixing to the ground
- 10m hose with the regulator for connecting to the gas cylinders
- FirePower Gas torch for lighting the burner (you will need a 400g disposable cylinder of propane for this - (see above))
- Spanner
- Leak detecting fluid
- Hose assembly and Y manifold to link 2 cylinders
- Lighting and safety instructions

The above items are packed into 2 strong cartons.



The tripod describes a circle area of about 1.32m diameter and the beacon has an extended height of about 2.15m.

The Beacon (and flame) are stable in the wind up to 30 mph. It is supplied with a ground anchor and rope for securing to the ground if this is possible, or else we would recommend the use of sand bags. Full instructions are provided for this. The Beacon must be supervised by 2 people at all times when lit and a fire extinguisher must be provided. It is important that the supervisor should be undertaken those who are competent and it is essential that a trial be undertaken before the event to ensure that everyone is fully trained and familiar with the operation.

See our website bullfinch-gas.co.uk for more details.

The price is £360 plus VAT including carriage within the UK. Mainland. There will be an extra carriage charge for other areas.

To order please contact:

Bullfinch Gas Equipment, Kings Road, Tyseley, Birmingham, B11 2AJ.

Tel: 0121 765 2000

Fax: 0121 707 0995

Email: sales@bullfinch-gas.co.uk

Web: www.bullfinch-gas.co.uk

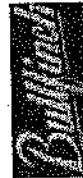

Payment by Bank Transfer, Credit/Debit Card or Cheque. Payment will not be asked for until the Beacon is about to be despatched. Last date to order to guarantee delivery by 1st November is 31st August 2018. However please enquire after this date for availability.

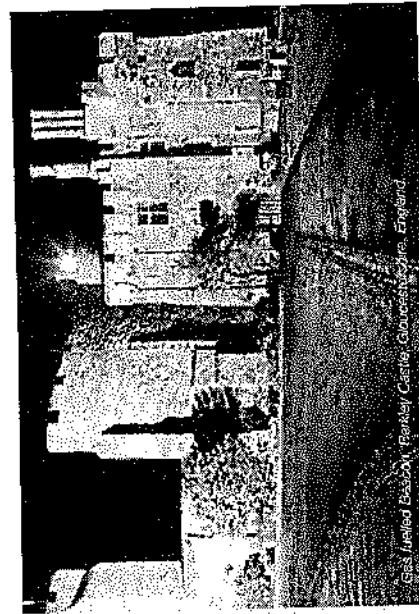
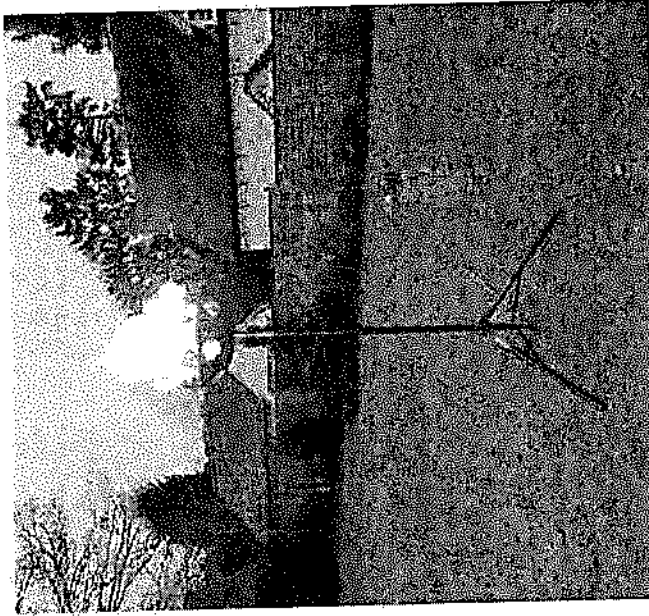

WWI Beacons of Light, Beacon Brazier

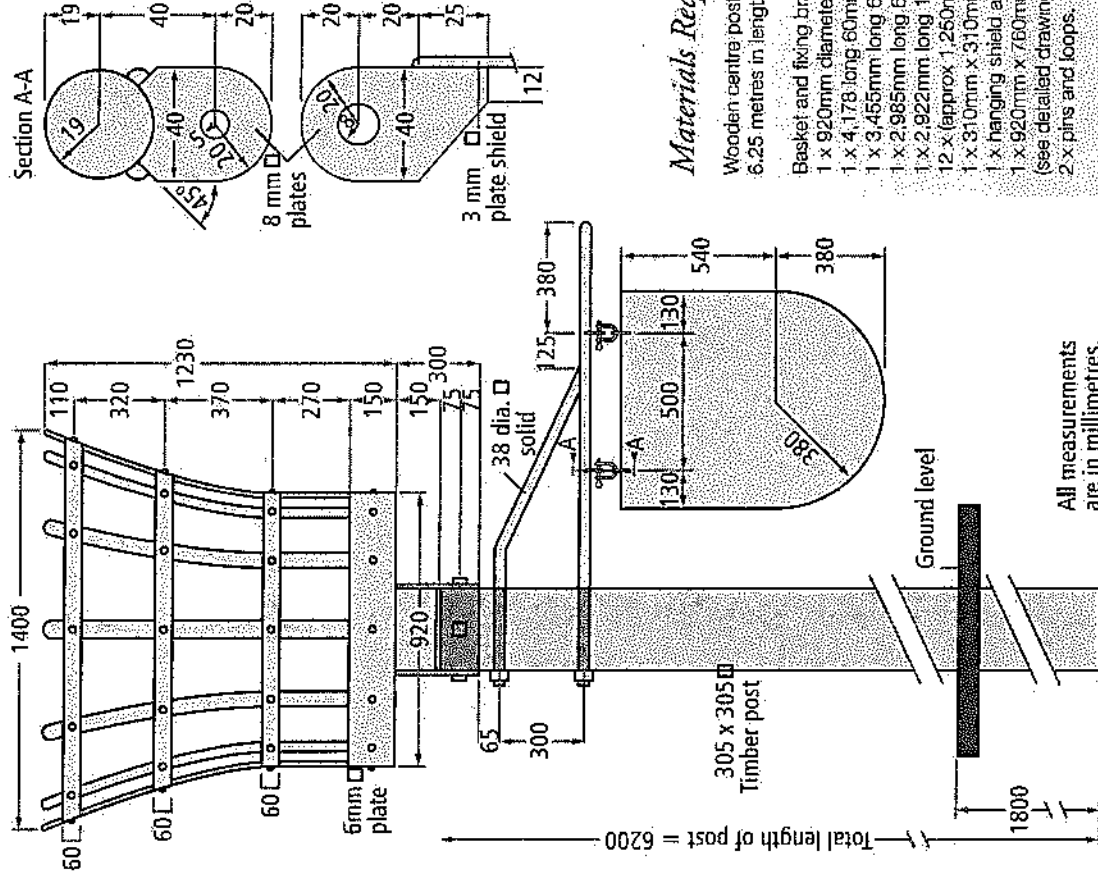

Beacon Brazier with Metal Shield

A Beacon Brazier can be a more permanent fixture, sited in a country park, hilltop or village green, as a lasting memorial of this important moment in history commemorated, and could be manufactured and erected by using local craftsmen.

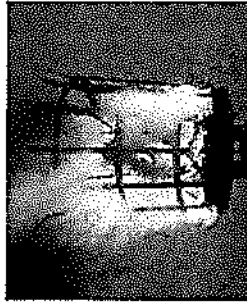

Materials Required for Beacon Construction

Wooden centre post consisting of 305mm x 305mm wooden post, 6.25 metres in length of which 2 metres goes into the ground.

Basket and fixing brackets consisting of:

- 1 x 920mm diameter steel plate
- 1 x 4,178 long 60mm x 5mm steel flat bar rolled into 1,330mm diameter ring.
- 1 x 3,455mm long 60mm x 5mm steel flat bar rolled into 1,100mm diameter ring.
- 1 x 2,985mm long 60mm x 5mm steel flat bar rolled into 950mm diameter ring.
- 1 x 2,922mm long 150mm x 5mm steel flat bar rolled into 930mm diameter ring
- 12 x (approx 1,260mm long) 60mm x 5mm vertical bars (rolled to shape).
- 1 x 310mm x 310mm x 300mm high connection box (rolled to shape).
- 1 x hanging shield and support: 3,7m length of 38mm diameter solid steel rod.
- 1 x 920mm x 760mm steel plate 3mm thick 4 x connection brackets 8mm thick (see detailed drawings left).
- 2 x pins and loops.

All measurements are in millimetres.

WWI Beacons of Light Bonfire Beacon

Locate the bonfire at least 30m away from buildings, roads, railways and public rights of way, and a safe distance from dangerous materials and overhead power lines. Ensure it has good access for the transportation of materials for the bonfire and sufficient space for spectators to stand upwind.

Obtain the landowner's permission and involvement.

Liaise with local fire brigade and emergency services, presenting them with your plans, and seek their advice and support.

1 Prepare site by removing top layer of turf and stack away from fire area. Obtain seven poles, 5-6m in length. Attach four guy ropes to top of one pole and anchor as shown.

2 Erect remaining poles as shown, ensuring tops are secured in place.

3 Use either pallets or suitable lengths of timber, spreading them over ground area of beacon for a good through draught. Secure timber horizontally between poles as shown, preventing material placed over the framework from dropping through. Construct access

tunnel to the middle of the beacon. Keep middle empty until required. Always construct the bonfire so it collapses inwards as it burns.

4 Use only wood for combustible materials. Do not burn dangerous items such as foam-filled furniture, old tyres, aerosols or tins of paint. Build upwards until height of centre pole is reached. Materials around top should be loosely packed to allow air flow. Cover bonfire to keep it dry.

5 Fill centre with suitable, dry combustible materials. Check construction is stable and remove any unsuitable materials that may have been added. Look specifically for fireworks, aerosols, highly inflammable materials or containers with such materials.

6 Construct a safety barrier out of ropes and stakes or scaffold poles to ensure public is kept at a safe distance from the fire.

7 In daylight, and just before lighting, check that there are no children or animals playing or hiding in the bonfire. Arrange for and brief sufficient numbers of marshals.

8 The person looking after the fire should not wear lightweight clothing that could ignite easily. They should wear a substantial outer garment of wool, or other material of

low flammability, and stout boots. They should know what to do in the event of a burn, injury, or a person's clothing catching fire, and should have a fire blanket ready in the bonfire area along with a number of fire extinguishers.

9 Lighting: the safest and recommended approach is to use paper and solid firelighters in six places just inside the walls of the beacon to ensure an even burn. Never use flammable liquids such as paraffin or petrol to get it going as this can result in uncontrolled spread of fire or explosion.

10 To light the beacon: from poles 2m in length, prepare hand torches for lighting with paraffin-soaked rags wired around one end. Remember, paraffin is dangerous and great care should be taken. Paraffin can be used as directed, but it is still dangerous and should at all times be treated with great care - for example, always ensure all excess paraffin is drained off rags before use. If spilt on your clothes during the preparation of your beacon lighting you should replace those items of clothing before approaching any naked flames. In particular, always remember to replace the lid on any container of unused paraffin and store it in a safe place away from naked flames. Do not use an accelerant on the fire itself.

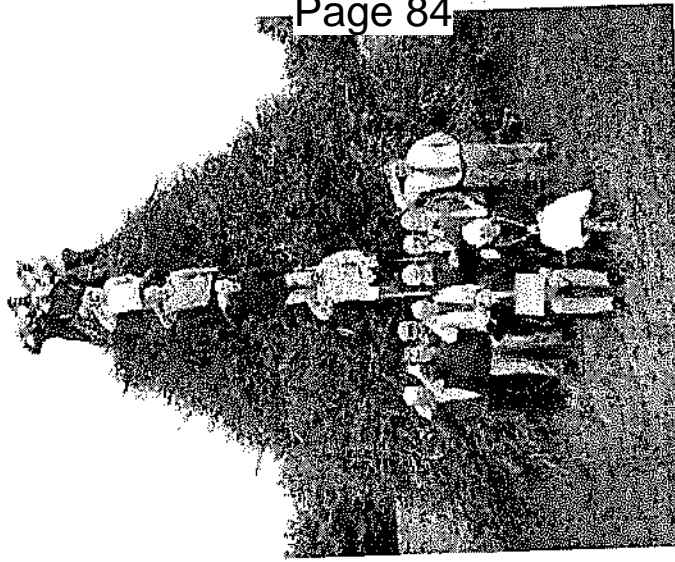

Bonfire Beacon, Shipston-on-Stour, Warwickshire, England.

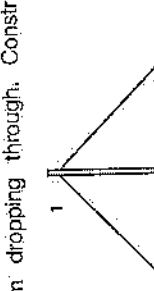
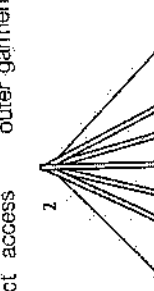
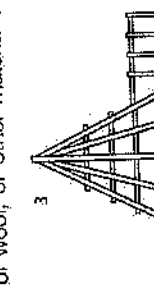
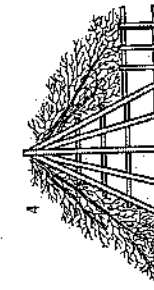
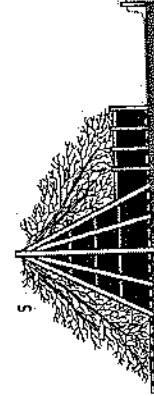
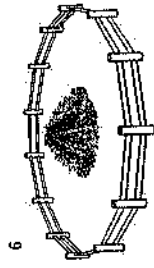

▲ Leave site clean and tidy.

▲ Dig over site and re-lay turf.



Your Legal Essentials and Safety

If you are inviting personal guests to your home it is worth checking with your household insurer that you are covered in the unfortunate circumstances that there should be an accident. If your event includes inviting the public, or it is a third party venue then, where applicable, the following advice should be heeded, to ensure you have a safe and enjoyable event for everyone involved.

Licensing

Your local authority is responsible for licensing of such events. This includes the sale of alcohol (please see separate section) and Regulated entertainment, which includes live and recorded music along with other types of entertainment. Generally if there are going to be no more than 499 people present at your event, including staff and performers you can apply for as Temporary Event Notice. This is a simple process and can be obtained from your local Council and completed on line for only £21, if you expect more than the 499 people you will require a Premises licence to allow your event to take place. This process takes at least 28 days after you have submitted your forms, so leave plenty of time, the process may seem complicated but you can get assistance from your local licensing service at the Council. Local authorities will treat each event individually. The licensing officer's job is to advise the local authority's licensing committee on the granting of a licence should anyone object. If there are no objections the licence will be granted but you may have to agree to some conditions. It is always worth checking before you apply with the Councils licensing service to see if location already has a licence, as some open spaces are already licensed. Talk to the licensing officer as soon as possible, in Northern Ireland, if you plan to sell alcohol at an event, you will need to apply for an occasional liquor license from the Northern Ireland Court Service.

Safety Advisory Groups

A lot of local authorities run Safety Advisory Groups for events, these groups consist of all emergency services plus other members such as the Highways authority. They can provide you with all the information you require and some have example event plans to assist you organising your events, you can normally contact them through your local Council or the Police events officers.

Insurance

Unfortunately accidents can happen at even the best organised events. Therefore you will need to consider and obtain insurance cover for your event, whether you are holding an event on your own premises or someone else's. Beacon/Bonfire events require specialist public liability cover. If you hire a park or venue or use land owned by a third party for your activity, they are likely to require you to have your own suitable insurance to cover your liability for any injury to the public or damage to other people's land or property. If hiring equipment for the event, you may need to insure these items; you may also need to consider cover for loss of any financial outlay you incur if the event has to be cancelled for reasons beyond your control, or loss of money, particularly if you are holding a fund-raising event. To help you obtain the appropriate insurance, and risk management advice, we are working closely with Unity Insurance Services, which is a specialist insurance broker in the voluntary and non-profit sector. They have developed a range of bespoke insurance covers specifically for the Beacon/Bonfire events. Unity is owned by a charity, The Scout Association, and donates all its profits back to charity. To obtain a quote or for more details or advice on the insurance cover you may need, please visit Unity's website, www.unityinsuranceservices.co.uk/beacons or telephone them on 0345 040 7702.



Alternatively, the licensing officer may be able to direct you to a suitable specialist company or broker, but you should not try to source this kind of insurance from a non-specialist.



Emergency Services

Tell the police well in advance about the type of event you are planning, and get in touch with your local community police officer. Write to the fire brigade and ambulance service, particularly if you are planning to have a Beacon/Bonfire, fireworks, or an event that will attract a large crowd. St John's Ambulance and the British Red Cross will provide first aid and sometimes a vehicle. You can be expected to be charged for these services. If your Council has a Safety Advisory group this process will be part of the process and will save time.



Food and Drink

Basic food hygiene guidelines should be followed at all times if you are providing food and drink. Caterers must have food hygiene certificates. Advice on this subject can be obtained from your local council environmental officer. If you are using outside catering companies check with your local authority to see if they are a registered food business.



Alcohol

If you wish to sell alcohol at your event you will need to obtain a licence, please see the section above on licensing, it is important that you obtain the correct permissions and your local authority Licensing service will help you do this. You can normally use a temporary events notice for a bar as only a small number of people can be present (less than the 499 limit).



Site Clearance

The local authority will arrange for clearance and disposal of litter after your event if it is on public ground (check for possible charges). You can help this process by arranging litter bins or recycling bins around the site, and a crew to clear up throughout the event.



Hiring or Borrowing Equipment

Your local authorities, or local event organisers may be able to help you with contacts for supplies such as marquees, portable toilets, barriers and bunting, or may in some cases have these for you to hire and borrow. You may also need to consider generators, a public address system, and emergency flood lighting. If you need to arrange insurance for your hired equipment, Unity Insurance Services can arrange this for you too. If you hire a Marquee make sure the company providing it provide you with the necessary safety certificates.



AB Ability Access

Access for the disabled is very important. Many local authorities run community transport schemes. Talk to them about arranging transport. On green field sites access may be improved by cutting the grass before the event.



The Royal Naval Association is proud to be associated with 'Battle's Over - A Nation's Tribute'

With over 16,000 members across 300+ branches in the UK and overseas, we are a family of current and former Naval Service personnel, relatives and supporters of our country's Royal Navy.

Whether we are catching up with friends at our regular social events; fundraising; advising on welfare and employment matters, or just providing an arm around the shoulder, our natural willingness to help others stems from the tradition and camaraderie that only Naval Service life can instil. Everything we do is inextricably linked to our core values:

Unity

Shared backgrounds and equality in rank. We share the same bonds, the same mindset, and even the same language (Jackspeak!). We are all equal. We are the heart and soul of the RNA.

Loyalty

To each other and our dependants. We will always support and look out for each other. Our loyalty is to all our shipmates, our local communities, the personnel and dependants of the Naval Service, along with other charities or organisations with naval connections.

Patriotism

We are proud to serve and proud to represent our country and the Naval Service. Our pride in serving our country never leaves us. Nor do we forget those who have fallen for our country or who fight now. We are deeply honoured to represent them on both a national and international level.

Comradeship

Friends in fun, fellowship and need. Your shipmates will always be here for you, whether it's about a job, ideas for a fun day out or just an arm around the shoulder. We will never leave you or your dependants in despair.

The Royal Naval Association has lots of great things going on:

- Project Semaphore to bring digitally isolated naval veterans online.
- Befriending naval veterans who need an arm around the shoulder.
- 3 minibuses fitted with wheelchair hoist for socially isolated veterans.
- Support for those leaving the Royal Navy - the Shipmates and Oppos programme.
- We support and lead the Conference of Naval Associations, a group of 70 like-minded naval associations, bringing great benefits and working together. www.cona.org.uk/

- Most importantly we have fun together with our regular meetings and organised events - such as our annual reunion and Conference and the Remembrance Sunday march at the Cenotaph.

The RNA has been involved with many aspects of commemoration of the First World War.

- Our National Standard led the parade at the National Event at Lyness cemetery on the Orkneys for the Battle of Jutland, our members have been part of many events.
- We have lent the Chapel door of HMS WARSPITE to the National Museum of the Royal Navy - for their Jutland Exhibition running in Portsmouth from 2016 to 2020.
- We are the lead sponsor with the Woodland Trust in the establishment of the Jutland Wood as part of their WW1 Centenary Wood Project. The wood will consist of 6,094 trees - reflecting the number of Royal Navy sailors who lost their lives on that day in May 1916. The RNA has sponsored two of the large specimen trees in the main avenue, and hope to have members at the planning at Langley Vale Epsom in the Winter of 2017.

www.royal-naval-association.co.uk

RNA Central Office, Room 209, Semaphore Tower,
HM Naval Base, Portsmouth, PO1 3LT

admin@royalnavalassoc.com
02392723747

You can donate to the RNA at:
www.royalnavalassoc.com/uk/about-us/help-us/

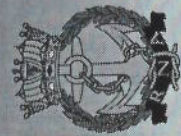

ROYAL NAVAL ASSOCIATION

ABF The Soldiers' Charity is the National Charity of the British Army. Originally established as the Army Benevolent Fund in 1944, we provide a lifetime of support to soldiers, veterans and their immediate families in times of need.

How we help

We give financial assistance to individuals as well as make grants to a large number of specialist charities and partner organisations such as Combat Stress, SSAFA and the NSPCC, which provide support on our collective behalf.

The scope of our work is huge; from providing funding for specialist medical equipment for the 6-month old child of a serving soldier, to assisting with the care home fees of a 105-year-old veteran, our work touches the lives of around 80,000 people each year, sustaining the British Army 'family' both at home and around the world. We are The Soldiers' Charity: 'For Soldiers - For Life'.

How you can help

From abseils, skydives and 24-hour hikes across the Scottish wilderness, to cake sales, big curries and cycling challenges, there are many ways for you to get involved and support our work. However you choose to support us, your contribution will go a long way to making a difference to the lives of serving and veteran Army personnel, and their families.

We don't receive any statutory government funding, so we rely on the generosity of our supporters to ensure we can continue to be here, supporting the men and women of the British Army.



The Army's National Charity

For more information on The Soldiers' Charity or to make a donation, visit www.soldierscharity.org or email info@soldierscharity.org



facebook.com/soldierscharity



[@soldierscharity](https://twitter.com/soldierscharity)



instagram.com/soldierscharity

ABF The Soldiers' Charity is a registered charity in England and Wales (114629) and Scotland (039189). Registered as a company limited by guarantee in England and Wales (07376609).

Registered Office: Mountbatten House, 12 Elizabeth Street, London SW1W 9BB

THE HEART OF THE RAF FAMILY SINCE 1919



**Royal Air Force
Benevolent Fund**
THE HEART OF THE RAF FAMILY

Since our foundation in 1919, the RAF Benevolent Fund has been there, through thick and thin, supporting the RAF family.

Our principal activities are to provide assistance to the RAF family when they are in need, maintain and preserve the RAF Memorial in London on behalf of the nation, support the morale and wellbeing of the serving RAF and be responsible for the Bomber Command Memorial in central London.

HOW WE HELP

We routinely help over 41,000 individuals every year, by providing a range of support aimed at serving and former RAF personnel. We also support members of the Air Cadet Organisation, including members of the Combined Cadet Force RAF component, if they are injured whilst on duty.

They include welfare breaks for families and veterans, grants to help with getting about inside and outside the home, specialist advice on benefits and care services, individual grants for RAF Stations and Station personnel and support for young people through our Airplay programme.

By working with others, we ensure that members of the RAF family get the right support, when it's needed. Last year we gave over £1m in external grants to over 50 charities and organisations including RAFA, SSAFA and the Royal British Legion.

HOW YOU CAN HELP

There are lots of ways you can get involved with the RAF Benevolent Fund and we always welcome your support.

And don't forget whatever you do, no matter how small, will go a long way in helping us make a difference to the lives of RAF personnel, past and present, and their families. From cake sales to fun runs, cycling challenges to dinners, your support matters.

We receive no regular government funding, so we rely entirely on people like you to continue our work supporting the men, women and children of the RAF family whenever they are in need.

For more information on the RAF Benevolent Fund or to make a donation, visit www.rafbf.org, or email info@rafbf.org.uk.





The Merchant Navy Association

from ship to shore, from past to present

The merchantile marine, as it was termed in those times, played a significant and often critical role throughout the First World War...much the same as it would two decades later. In both world wars merchant seafarers and fishermen fought the enemy, the weather and the seas to keep the nation and the Armed Services supplied and able to defend themselves. Their way of life and conditions of service were austere with seafarers often not returning home for over two years, some having been sunk, survived and transferred to other ships to maintain those lines of support.

During the First World War attacks on merchant and fishing vessels began quite slowly but increased significantly as the enemy sought to blockade Great Britain. In 1914 and 1915 a total of 342 merchant vessels were lost to enemy action with 2,471 men, women and boys losing their lives. During 1916 there were 396 ships and 1,217 seamen killed. In the following year, 1917, the losses were so severe that the ships being built could not match the number of ships being lost in action with six ships a day being sunk on some days. The loss of life was increasing significantly. It was so severe that if the rate of losses of ships and men had continued the war would have been lost. No food, no fuel, no wood, no arms and ammunition especially some of the 91 million shells that were eventually produced and transferred by sea. In that year 1,197 ships were sunk through enemy action and 6,408 seamen were lost at sea with their ships...their only grave the sea. The losses had to be decreased and this was achieved by the introduction of the Convoy System in 1917. In 1918 the impact of the actions in the previous year were clearly evident with 544 ships and 4,122 seamen lost.

The total recorded losses for the First World War were 2,479 ships and 14,287 seamen plus 675 vessels of the fishing fleet and 434 seamen. There were many more seafarers who died ashore and were not commemorated. They had to die at sea to be commemorated even when they were hospitalised because of their wounds. They were also off pay when their ships were sunk. They actually had to die at sea to be commemorated.

The men, women and boys who were lost at sea during the First World War included lads such as Redan Sydney Jeffries (aged 13) of Lowestoft, presumed drowned on 24th October 1917. Redan was a Cook aboard the fishing vessel Vanguard. More than twenty-nine Boy seamen aged only 14 lost their lives for their King and Country. At the other end of the scale were men long overdue for retirement who insisted on "doing their bit" and who paid the ultimate sacrifice. Men such as A.B. Patrick Casey, aged 73, killed when the S.S. Dotterel was sunk by a mine off the French coast on 29th November 1915....they were the forgotten heroes, their lines of support were never broken.

Capt J M R Sail MNM MNI, MNA National Chairman

Please donate what you can, when you can, as often as you can. Small donations will make a big difference.

Contact www.mna.org.uk and access the DONATE button.

Battle's Over - A Nation's Tribute to WWI Beacons of Light

Acknowledgements

This event is being organised in association with:

The Army Cadet Force, Air Training Corps, Sea Cadet Corps, Combined Cadet Force, Association of English Cathedrals, Royal Naval Association, The Buglers Association of The Light Division & Rifles, Trinity House, National Association of Local Councils, National Association of Civic Officers, One Voice Wales, National Trust, English Heritage and the National Union of Mineworkers (formerly known as Miners Federation of Great Britain).

We would like to thank the many and various councils, churches, organisations, local communities, commercial companies, private land owners and others to date listed below, for their generous participation in this unique, local community tribute.

There are a number of others taking part as private occasions, so are not open to the general public so have asked not to be listed.

(The Merchant Navy Association will be lighting 12 further Beacons, the locations of which will be confirmed nearer the date).

ENGLAND

BEDFORDSHIRE

Leighton-Linslade Town Council
 Silsoe Parish Council
 Potton Town Council
 Luton Borough Council
 Billington Parish Council
 Stanbridge Parish Council
 Shefford Town Council
 Millbrook Parish Meeting

BERKSHIRE

Wraysbury Parish Council
 Newbury Town Council
 Slough Borough Council
 Datchet Parish Council
 Englefield Estate
 Royal Borough of Windsor and Maidenhead & Crown Estate
 Hungerford Town Council
 Sunningdale Parish Council
 Donnington Castle - (English Heritage)

CHEESHIRE

Northwich Town Council
 St Oswald's Church - Lower Peover
 Beeston Parish Council & Beeston Castle
 Alsager Town Council
 Tushingham, Macfen & Bradley Parish
 Winsford Town Council
 Frodsham Town Council & Frodsham WWI
 Commemoration Working Group
 Disley Parish Council
 Little Budworth Parish Council
 Wybunbury Parish Council
 Beeston Castle - (English Heritage)

CLEVELAND

Billingham Town Council

CORNWALL

St Michael's Mount (FAR WEST TIP OF ENGLAND)
 Torpoint Town Partnership
 Lizard Lighthouse - Trinity House
 Pelynt Parish Council

St Mabyn Parish Council
 Liskeard Town Council
 St Stephens by Launceston Rural Parish Council
 Penzance Town Council
 Helson Town Council & Helston WWI Heritage Project
 South Petherwin Parish Council
 Madron Parish Council
 Gwennap Parish Council
 Marazion Town Council
 Carn Brea Parish Council
 Probus Parish Council
 St Enoder Parish Council
 Morval Parish Council
 The Ruan Social Group (RSG)
 St Cleer Royal British Legion - & other organisations
 Rotary Club of Bodmin





Acknowledgements

COUNTY DURHAM	Bewcastle Parish Council	Newton Abbot Town Council (3 Beacons)	Bognor Regis Town Council
Brandon and Meadowfield Royal British Legion	Dearham Parish Council	Lifton Parish Council	Heathfield and Watdon Parish Council
Shofley Bridge Cricket Club	Millom Town Council	South Tawton Parish Council	Newick Parish Council with Newick Bonfire Society
Ferryhill Town Council	Blindbothel Parish Council	Okehampton Hamlets Parish Council	
Hartlepool Borough Council	Carlisle Castle – (English Heritage)	Chagford Parish Council	
Waldridge Parish Council	Birdoswald Roman Fort – (English Heritage)	Strate Parish Council	
St Andrew's Church - Winston		Peter Tavy Parish Council	
Brandon & Byshtoles Parish Council	DERBYSHIRE	Newton Popholeford and Harford Parish Council	EAST YORKSHIRE
Manfield with Cliffe Parish Council	Erewash Borough Council (2 Beacons)		Rowley Parish Council
Great Aycliffe Town Council	South Derbyshire District Council	Bideford Town Council	Sutton upon Derwent Parish Council
Barnard Castle Town Council	Shardlow Church and Shardlow & Great Wilne Parish Council	Clifford Estate Company Ltd & Chudleigh Town Council	Market Weighton Town Council
Spennymoor Town Council	Durfield Parish Council	Luppitt Parish Council	Kilpin Parish Council
Coxhoe Parish Council	Pilsley Parish Council		Hesle Town Council
Barnard Castle – (English Heritage)	Northwood and Tinkersley Parish Council	DORSET	Sancton All Saints Church PCC
Eggleson Parish Council	Bridwell Parish Council	Portland Bill – Trinity House	Withernsea Town Council
	Aston-on-Trent Parish Council	Sturminster Newton Town Council	Hedon Town Council
CUMBRIA	Horsley Woodhouse Parish Council & Horsley Woodhouse Scout Group	Bournemouth Council	Beverley Town Council
Brampton Parish Council	Whaley Bridge Town Council	Beaminstor Town Council	ESSEX
Provincial Grand Lodge of Cumberland and Westmorland Freemasons	High Peak Borough Council	Bere Regis Parish Council	Broxted Parish Council
Whitwell and Selside Parish Meeting	Chelmeron Parish Council	Charmouth Parish Council	White Colne Parish Council
Mansergh Parish Meeting	Derbyshire & Lancashire Gliding Club		Burnham-on-Crouch Town Council
Heversham Parish Council	Peveril Castle – (English Heritage)	EAST & WEST SUSSEX	Wivernhoe Town Council
Maison Ground Estate Co Ltd		Crowborough Town Council	Harwich Pier – Trinity House
Cumberland & Westmorland Freemasons		Community of Brightling Village	St Lawrence Parish Council
Windermere Lodge 2217		Wave Leisure Trust Ltd	Rochford District Council
Windermere Town Council		Shining Lights (Bexhill Ltd)	Fryerning Parish Council
Torver Parish Council		Winchelsea Antefacts Society	Waltham Abbey Town Council
Coniston Parish Council		Crawley Borough Council	Harwich Society
Dalston Parish Council		1st Horam Scout Group & Horam Parish Council	High Easter Parish Council
Milburn Parish Council			St Lawrence PCC
Muncaster Parish Council (3 Beacons)		Alfriston Parish Council	Maldon District Council
West Cumberland Freemasons		Burwash Parish Council	West Bergholt Parish Council
Lamplugh and District Heritage Society & Lamplugh Young Farmers		Northiam Parish Council	Loughton Town Council
Maryport Town Council		Hamsey Parish Council & East Chillington Parish Council	Billericay Town Council
Scalby Parish Hall Committee		Willington and Jevington Parish Council	Great Bentley Parish Council
Boole Parish Council, Millom Without Parish Council and Whigham Parish Council		Milland Parish Council	Great Canfield Parish Council
		Uckfield Town Council	Colchester Borough Council
		Hoos Parish Council	Great Totham Parish Council
			Margaret Roding Parish Council
			Little Easton Parish Council
			Ilford East Scout District



Acknowledgements

- GLoucestershire**
 Girlguiding Gloucestershire
 Wotton Under Edge & District Round Table
 Stow on the Wold Town Council
 Lydney Town Council
 Cheltenham Trust & Cheltenham Town Hall
 Wickwar Parish Council
 Oldbury on Severn Parish Council
 Windrush Parish Meeting
 Adlestrop Village
- GREATER MANCHESTER**
 Stockport Metropolitan Borough Council
 Tameside Council & Tameside Armed Services Community
 Manchester Cathedral
 Bolton Metropolitan Borough Council
- HAMPshire**
 East Meon Parish Council
 Odilham Parish Council
 Liss Parish Council
 Candovers Parish Council
 Portsmouth City Council
 Bramley Parish Council
 Damerham Parish Council
 Denmead Parish Council
 Hythe Marina Centre
 West End Parish Council
 Bishop's Waltham Parish Council
 Hythe and Dibden Parish Council
 Overton Parish Council
 Hurst Castle – (English Heritage)
 Porchester Castle – (English Heritage) in association with Fareham Borough Council
- HEREFORDshire**
 Hereford City Council
 Ross-on-Wye Town Council
- HERTFORDshire**
 Benington Recreation Ground Charity Trust
 Hornead Community Group
 St Stephen Parish Council
 Highfield Park Trust
 Stevenage Borough Council
 Herefordshire County Council
 Shenley Parish Council
 Perry Green and Green Tie Preservation Society
 Welwyn Hatfield Borough Council
 St Albans City and District Council
- ISLE OF WIGHT**
 St Catherine's Lighthouse, Southern Tip of the Isle of Wight – Trinity House
 The Royal British Legion – Isle of Wight County Committee
 Carisbrooke Castle – (English Heritage)
- KENT**
 East Peckham Parish Council
 Temple Ewell Parish Council
 Hildenborough Parish Council
 Canterbury City Council
 Westernhanger Castle & Stanford Parish Council
 8th Sheppey Scout Group
 Dymchurch Parish Council
 North Foreland – Trinity House
 Petham Village
 Yalding Parish Council
 River Parish Council
 Benenden Parish Council
 Hawkhurst Parish Council
 Chistlet Parish Council
 Rushall Parish Council
 Aldington and Bonnington Parish Council
 Saint Peter and Saint Paul's Church – Farningham
- LANCASHIRE**
 Staining Parish Council
 Earby Town Council
 West Lancashire Borough Council
 Whittington Parish Council
 Wyre Council
 Chorley Council
 Fylde Borough Council
 Lancaster City Council
 Pilling Parish Council
 Duchy of Lancaster – Lancaster Castle & Lancaster City Council
 Whitworth Town Council
 West Bradford Parish Council
 Girdleton Parish Council
 Cronton Parish Council
 Hambleton Parish Council
 Breighton Parish Council
 Bold Parish Council
 Ribby with Wrea Parish Council & Westby with Plumpton Parish Council
 Little Eccleston and Larbreck Parish Council
 Preesall Toon Council
 Slaiburn & Easington Parish Council
 Whittle-le-Woods and Clayton-le-Woods War Memorial Committee
 Mellor Parish Council
 Whittle-le-Woods Parish Council
 Catforth Village Memorial Hall
- SPRINGFIELD**
 Snodland Town Council
 St Nicholas-at-Wade & Sare Parish Council
 Lymington Parish Council
 Lydd Town Council
 Hever Residents Association and Hever Parish Council
 Bibborough Parish Council
 Broadstairs & St Peter's Town Council
 10th Deal Easry Scouts
 Ashford Borough Council
 Friends of Chapel Church
 Badlesmere Parish Hall
 Great Chart Remembers – Great Chart
 Easry Parish Council
 Tenterden Town Council
 Birchington Parish Council
 Borough Green Parish Council
 Ploxal Parish Council
 New Romney Town Council
 Hartlip Parish Council
 Dover Town Council
 Newchurch Parish Council
 Woodnesborough Parish Council
 Lamberhurst Parish Council
 Chilham Parish Council
 Egerton Parish Council
 Sutton Valarice Parish Council
 Stockbury Parish Council
 Hartley Parish Council
 Deffing Parish Council
 Hoo St Werburgh Parish Council
 Leeds Parish Council
 Wye with Hirxhill Parish Council
 Harriestham Parish Council
 Wickhambreux Parish Council
 Mersham and Sevington Parish Council
 Westerham Town Council
 Horton Kirby and South Darenth Parish Council
 Staplehurst Parish Council
- Westwell Parish Council**
 Newington History Group – Newington
 Dover Castle – (English Heritage)
 Longfield and New Barn Parish Council
 Appledore Local History Society
 Teaton Parish Council
 Cranbrook & Sissinghurst Parish Council



Acknowledgements

LICESTERSHIRE

Husbands Bosworth Parish Council
Leicestershire County Council
Fleckney Parish Council
Great Easton Parish Council
Broughton Astley Parish Council
Ashby de la Zouch Town Council
Thorpe Acre Scout Group
Barkby and Barkby Thorpe Parish Council
Earl Shilton Town Council

LINCOLNSHIRE

International Bomber Command Centre
Worlaby Parish Council
Hilbilstow Parish Council
Elsham Parish Council
Corby Glen Parish Council
Haxey Parish Council
Pinchbeck Parish Council & St. Mary's Church
Deeping St James Parish Council
Stapleford Parish Meeting
Metheringham, Sots Hole and Tenvats Parish Council
Epworth Town Council
Soppwick and Kirkby Green Parish Council
Scrivelsby Estate
North East Lincolnshire (3 Beacons)
Louth Town Council
Barrowby Parish Council

LONDON

Merchant Navy Association National Memorial
-- Tower Hill, London
Royal Borough of Greenwich (3 Beacons)
Barnet Borough Scouts
London Borough of Havering
Ealing Council
London Borough of Islington
London Borough of Camden

MERSEYSIDE

Billinge Chapel End Parish Council

NORFOLK

Thorpe St Andrew Town Council
Potters Leisure Resort
Melton Constable Parish Council
Cromer - Trinity House
The Greyhound Inn - Hickling
Shouigham Parish Council
Asthill Parish Council
Norfolk Tank Museum
Lingwood and Burlingham Parish Council
Wells Harbour Commissioners
Honing Village Hall
Theford Town Council
Claxton Parish Council
Letheringsett with Glandford Parish Council
Wiveton Parish Council
Downham Market Town Council
Ashwellthorpe and Fundenthal Parish Council
Overstrand Parish Council
Necton Parish Council
Marshland St James Parish Council
Waipole Cross Keys Parish Council
Barton Bendish Parish Council
Swanton Nevers Parish Council
Langham Parish Council
Norwich City Council
Great Yarmouth Borough Council
Rollesby Parish Council
Blakeney Parish Council
Surlingham Parish Council
Dersingham Parish Council
Attleborough Town Council
Gaivestone, Reymerston & Thuxton Parish Council
Hockham Parish Council
Wood Norton Parish Council
Regis Parish Council

Rollesby Parish Council

Chedgrave Parish Council
Hoveton Parish Council
Hardingham Parish Council and Village Hall Committee

Acle Bridge Inn, Acle
Great Massingham Parish Council

Tittleshall Parish Council

Norfolk District Council

Headham Parish Council

Stoke Ferry Parish Council

Dickleburgh & Rushall Parish Council

Northrepps Parish Council

Fincham Parish Council

West Dereham Parish Council

Broome Parish Council

Morston Parish Council

NORTHAMPTONSHIRE

Thrapston Town Council
Corby Borough Council
Little Addington Parish Council
Raunds Town Council
Farthinghoe Parish Council
Brackley Town Council
Irthingborough Town Council
Northamptonshire County Council & All Saints' Church
Crick Parish Council
Grendon Parish Council
Harlestone Parish Council
Duston Parish Council
Cogenthoe and Whiston Parish Council
Litchborough Parish Council
Cold Higham Parish Council
Whittlebury Parish Council
Heldon Parish Council
Bozeat Parish Council

NORTHUMBERLAND

Heugh Hill (Holy Island) - Trinity House
Morpeth Town Council
Ambie Town Council
Ford & Etal Estates with the North
Northumberland Branch of The Royal British Legion
Lindisfarne Priory - (English Heritage)
Housesteads Roman Fort - (English Heritage)
Berwick-upon-Tweed Barracks - (English Heritage)

NORTH YORKSHIRE

Richmond Town Council
West Tanfield Committee
Danby Beacon Trust
Bentham Town Council
Masham Parish Council
Spofforth with Stockeld Parish Council
Skipton Town Council
Bewerley Parish Council
Tadcaster Town Council
Tan Hill Inn (HIGHEST PUB IN GREAT BRITAIN)
Barby and Osgoby Town Council
Leavingworth Parish Council
Settle Town Council
Goldsborough Hall
Willeby Parish Council
Ricoall Parish Council
Dalton on Tees Parish Council
Gatford Parish Council
Langthorpe Parish Council
Wistow Parish Council
Askham Richard Parish Council
Rudby Parish Council
Burton in Lonsdale Parish Council
Whitley Parish Council
Escrick Parish Council
Sherburn Parish Council

Acknowledgements

- Clapham cum Newby Parish Council
 Eskdaleside cum Ugglebarnby Parish Council
 Knaresborough Town Clerk
 Scagglethorpe Parish Council
 Baldersby & Baldersby St James Parish Council
 Great Ayton Parish Council
 Darley & Menwith Parish Council
 Settringham Parish Council
 Long Preston Parish Council
 Rawcliffe Parish Council
 Middleham Town Council
 Thirsk Royal British Legion in association with the Rotary Club of Thirsk
 Scarborough Castle – (English Heritage)
 Richmond Castle – (English Heritage)
 Whitby Abbey – (English Heritage)
 Pickering Castle – (English Heritage)
 Middleham Castle – (English Heritage)
 Roeliffe & Westwick Parish Council
- NOTTINGHAMSHIRE**
 Nottingham City Council
 Kimberley Town Council
 Clabrough and Welham Parish Council
 Flintham Parish Council
 Costock Parish Council
 Bunny Parish Council
 Wysall Parish Council
 Willoughby on the Wolds Parish Council
 Elston Parish Council
 Normanton on the Wolds Parish Council
 Shelford Parish Council – Nottinghamshire
 Plumtree Parish Council
 East Stoke Parish Council
 Whatton in the Vale Parish Council
 Thurgarton Parish Council
 Stanton on the Wolds Parish Council
 East Markham Parish Council
- OXFORDSHIRE**
 Wootton Memorial Playing Field Committee
 Abingdon-on-Thames Town Council
 Swinbrook & Widford Parish Council
 Upper Lea Farm
 Vale of White Horse & Faringdon Town Council
 Brightwell Baldwin Parish Meeting
 Lockinge Estate with Ardington & Lookinge Parish Council
 The Six Branch of The Royal British Legion
 Greatworth Parish Council
 Swyncombe Parish Council
- RUTLAND**
 Rutland County Council
 Barrowden
- SHROPSHIRE**
 Olive Parish Council
 Burwarton Estates
 Sibdon Parish Meeting
 Whixall Parish Council
 Cound Parish Council
 Ighfield and Calvernal Parish Council
 Much Wenlock Town Council
 Bayston Hill Parish Council & Bayston Hill Scouts
- SOMERSET**
 North Somerset Council
 Sedgemoor District Council
 A.H. Tollope-Bellew
 Long Ashton Community Association
 Peasedown St John Parish Council
 Kingsdon Parish Council
 Everard Family – Broford Farm
 Trull Parish Council
 Midsomer Norton Town Council
 Cucklington Parish Meeting
 Williton Parish Council
- Priddy Parish Council & Priddy Friendly Society
 Chard Town Council
 Clatworthy Parish Council
 Priston Parish Council
 St Cuthbert (Out) Parish Council
 Ilminster Town Council
- SOUTH YORKSHIRE**
 Tickhill Town Council
 Hunshelf Parish Council
 Charles & Rosalind Buckler
 Tankersley Parish Council
 Rotary Club of Sheffield Vulcan
 Heliaby Parish Council
 Austerfield Parish Council
 Penistone Agricultural Show
 Wales Parish Council
 Burghwallis Parish Council
 Sykehouse Parish Council
 Britsworth Parish Council
 Wadworth Village Hall Committee
 Conisbrough Castle – (English Heritage)
- STAFFORDSHIRE**
 Lichfield City Council
 Cheddleton & Wetley Rocks Parish Council
 Parish of Quinton & Admington
 Endon with Stanley Parish Council
 Cannock Chase Council
 Stone Town Council
 Rugeley Town Council
 Loggerheads Parish Council
- SUFFOLK**
 West Row Village War Memorial, West Row
 Bures St Mary Parish Council & Bures Royal British Legion
 Dukes Head – Somerleyton
 Levington and Stratton Hall Parish Council
- Orford & Gedgrave Parish Council
 Mendlesham Parish Council
 Sudbury Town Council
 Nacton Community Council
 Waveney District Council
 Little Thurlow and Great Thurlow Parish Councils
 Friston Parochial Church Council
 Ipswich Borough Council
 Metfield Parish Council
 Alderton Parish Council
 Burstall Parish Council
 Sproughton Parish Council
 Helton St Mary Village
 Barnham Parish Council
 Beccles Town Council
 Kedington Parish Council and Kedington & District Branch Royal British Legion
 Haverhill Town Council
 Aldbrough Town Council
 Glemham Hall Events
 Woodbridge Town Council
 Laxfield Parish Council
 Cockfield Parish Council
 Woolverstone Village with Woolverstone Parish Council & Ipswich High School for Girls
 Great Bealings Parish Council
 Bungay Town Trust
 Woolpit Parish Council
 Boxford Community Council
 Kirtton & Falkenham Parish Council
 Beck Row, Holywell Row & Kenry Hill Parish Council
 Whepstead Community Association
 Benhall & Sternfield Parish Council
 Clare Community Association (CCA)
 Brent Eleigh Parish Council
 Badingham Parish Council
 Capel St Mary War Memorial Trust
 Hepworth Parish Council



Acknowledgements

Rushmere St Andrew Parish Council
Norton Parish Council
Kettlebaston Parish Council
Hitcham Parish Council
Wissett Parish Council with Wissett
Community Council & Church Councils
Great Ashfield Parish Council

SURREY

Farnham Castle
Caterham Festival Committee
West End Parish Council
Normandy Parish Council
Guildford Borough Council & Guildford Lions
Clubs

Reigate and Banstead Borough Council
Worplesdon Parish Council
Royal British Legion (Pitbright Branch)
Lingfield Parish Council
Dormansland Parish Council

TYNE AND WEAR

Tynemouth Priory

WARWICKSHIRE

Royal Leamington Spa Town Council
Stratford-upon-Avon Town Council
Snitterfield Parish Council
Fillongley Parish Council
Harbury Parish Council
Priors Hardwick Village
Bishop's Itington Parish Council
Salford Priors Parish Council
Brinklow Parish Council
Colleshill Town Council
Ansty Parish Council
Budbrooke Parish Council
Leek Wootton & Guy's Cliffe Parish Council
Wolvey Parish Council

WEST MIDLANDS

St Stephen's Church – Rednal
Birmingham City Council
Solihull Metropolitan Borough Council
St Peter's Church – Wolverhampton
Wythall Community Association

WEST SUSSEX

Southbourne Sea Scouts
Burgess Hill Town Council
Littlehampton Town Council
Twineham Parish Council

WEST YORKSHIRE

Wakefield Metropolitan District Council
Strathmore/Blackshaw Parish
Hebden Royd Town Council
Clifford Parish Council
Hemsworth Town Council
Emley Millennium Green
Normanton Town Council
Collingham with Linton Parish Council
Kippax British Legion & Kippax Parish Council
R&CP Haigh and Sons
Barwick in Elmet Parish Council
Scholes Parish Council
Woolley Village Residents Association

WILTSHIRE

Manorial Court for the Hundred & Borough of
Cricklade
Steeple Ashton Bellringers
Semington Village
Sutton Benger Village Hall & Recreation
Ground Charity
Westbury Town Council
Stanton Saint Bernard Parish Council
Amesbury Town Council
Stratton St Margaret Parish Council
Stonehenge – (English Heritage)

WORCESTERSHIRE

Worcestershire County Council
Severn End Estate
Flippie Parish Council & Great Mongeham
Parish Council
Hindlip, Martin Hussingtree & Salwarpe Parish
Council
Romsley Parish Council
Kempsey Parish Council
Overbury Enterprises
Rock Parish Council

CHANNEL ISLANDS & ISLE OF MAN

SARK

STATES OF ALDERNEY
STATES OF GUERNESEY
STATES OF JERSEY

ISLE OF MAN

Isle of Man Government
Isle of Man Civil Defence

NORTHERN IRELAND

St Macartin's Cathedral (MOST WESTERLY
CATHEDRAL IN THE UNITED KINGDOM)
Antrim and Newtownabbey Borough Council
(2 Beacons)
Ards and North Down Borough Council
(3 Beacons)
Armagh City, Banbridge and Craigavon
Borough Council

SCOTLAND

Aberdeen City Council
Argyll Estates
West Lothian Council
North Ayrshire Council
The Royal Burgh of Annan Community
Council & Annan Branch of the Royal British
Legion
Perthshire Lieutenancy
Unst Community Council (MOST NORTHERLY
INHABITED ISLAND IN THE UK)
The National Trust for Scotland
Colby/Culsalmund (Williamston Estates)
Blackmannshire Council
Melthum and Bourlie Community Council
Old Rayne Community Association

WALES

St David's City Council (THE MOST
WESTERLY CITY IN WALES)
Amroth Village / Amroth Arms
Mumbles Community Council
St Anne's Head – Trinity House
Newport City Council
St Mary Hill Church
Carmarthen Town Council
Langynidr Beacon Council
Wrexham County Borough Council
Cowbridge with Llanblethian Town Council
Beaumaris Town Council
Welshpool Town Council (2 Beacons)
Magor with Undy Community Council
Fishguard and Goodwick Town Council
Menai Bridge Town Council
Penhow Community Council
Marletwy Community Council
Llandefalle Hall Committee





Acknowledgements

UNITED KINGDOM OVERSEAS TERRITORIES

Penally Community Council
 Pembrey and Blurry Port Town Council
 Usk Town Council
 Porskewett Community Council
 Whittou Community Council
 Caernarfon Royal Town Council
 Narberth Town Council
 Llansteffan and Llanybri Community Council
 Saundersfoot Community Council
 Montgomery Town Council
 Rhayader Town Council
 Langstone Community Council
 Llanwenog Community Council
 Rhuddlan Town Council
 Bridgend Town Council
 Cyngor Cymuned Dolbenmaen (Dolbenmaen Community Council)
 Llantwit Major Town Council
 Shirenewton Community Council
 (Monmouthshire)
 Dyffryn Cennen Community Council
 The Havens Community Council
 Cyngor Tref Criccieth Town Council
 Abergwyngregyn Regeneration Company (ARC) – Parish of Abergwyngregyn
 Llanfair Clydogau Village Hall Committee
 Llanfihangel Rhydfithon Community Council
 Mawr Community Council
 Abergavenny Town Council
 Abertillery and Llanhilleth Community Council
 Aberpoth Community Council
 Haverfordwest Town Council
 Cyngor Tref Tŷwyn/Tŷwyn Town Council

Government of South Georgia & South Sandwich Islands
 St Helena – South Atlantic Ocean Ascension Islands Government
 Falkland Islands Council
 Tristan da Cunha
 Government of the Virgin Islands
 Government of Bermuda
 Pitcairn Island

Battle's Over - A Nation's Tribute & WWI Beacons of Light

Chosen Charities

Please give generously to one or more of our chosen charities for this unique, historic tribute to the many that either died or returned home dreadfully wounded defending our freedom during the four dark years of World War I.

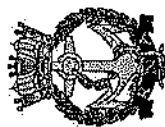

**ROYAL NAVAL
ASSOCIATION**

Please donate at:

www.royal-naval-association.co.uk/about-us/help-us/



**Royal Air Force
Benevolent Fund**
THE HEART OF THE RAF FAMILY

Please donate at:

www.rafbf.org/ways-to-give

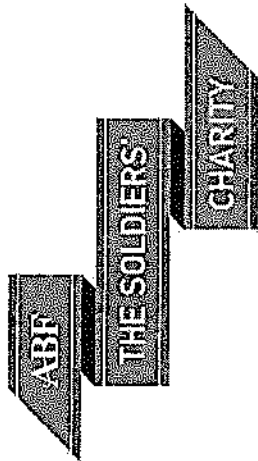

The Army's National Charity

Please donate at:

www.soldierscharity.org



The Merchant Navy Association

Please donate at:

www.merchantnavyfund.org



TMS Media - Pagemasters to the Pageantmaster

Few design agencies have the privilege of working on projects of national significance.

From celebrations to mark the 200th anniversary of the Battle of Trafalgar and the 90th anniversary of the Royal British Legion to Fly a Flag for the Commonwealth, TMS Media has had the pleasure of working with Pageantmaster Bruno Peek on events that celebrate many important milestones in our history and culture.

Much of Bruno's work has associations with historic anniversaries, for example, The Queen's Diamond Jubilee Beacons project was a high-profile televised celebration for which we designed a guide to taking part and a website for people and organisations to register events around the country.

Our creative work for the hugely successful Fly a Flag for the Commonwealth in 2013 also included a website and a guide, which has been updated to showcase some of the many exciting events that took place in its inaugural year.

We're delighted to be the Pagemasters to the Pageantmaster.

01493 662929 www.tms-media.co.uk



A unique 124-page leather-bound book listing all the Beacon occasions for The Queen's Diamond Jubilee Beacons was presented to The Queen 4 June 2012.

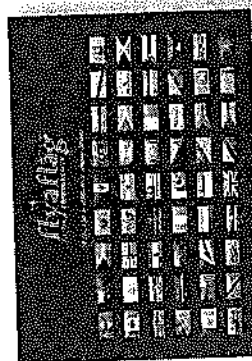
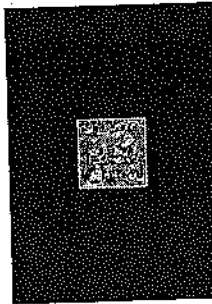
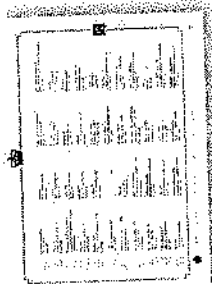

36-page guide to taking part for the Commonwealth Commonwealth 14 March 2016



20-page guide to taking part for The Queen's 90th Birthday Beacons 21 April 2016



24-page brochure for Trafalgar Weekend 21-23 October 2005.



8-page menu for Trafalgar Night Dinner 21 October 2005.



8-page guide to taking part in The Great Poppy Party Weekend 10-11-12 June 2011.



8-page guide to taking part for The Queen's Diamond Jubilee Beacons 4 June 2012.

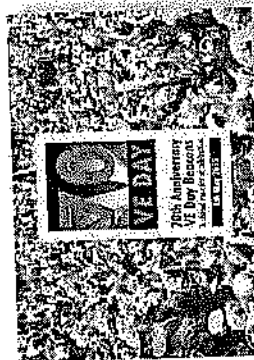

8-page guide to taking part for 70th Anniversary of VE Day 8 May 2015

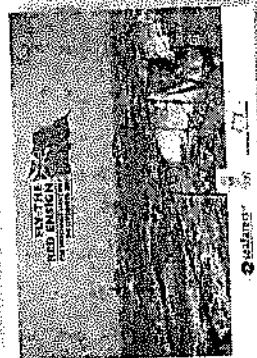

8-page guide to taking part for Merchant Navy Day 3 September 2015

BATTLE'S OVER

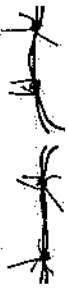

A NATION'S TRIBUTE
11TH NOVEMBER 2018
100 YEARS OF REMEMBRANCE

WW1 Beacons of Light 11th November 2018

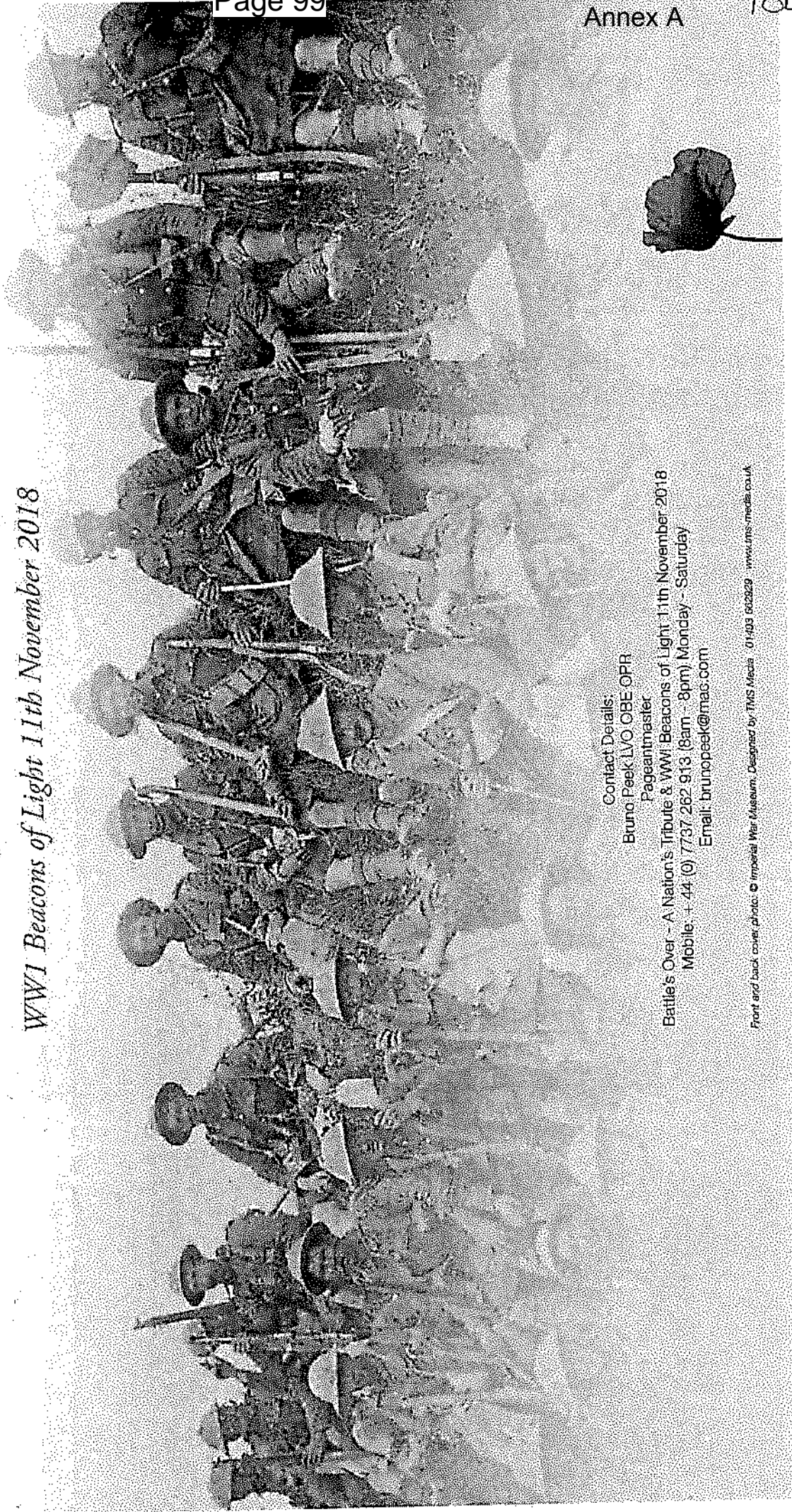

Contact Details:
Bruno Peek LVO OBE OPR
Pageantmaster

Battle's Over - A Nation's Tribute & WW1 Beacons of Light: 11th November 2018
Mobile: +44 (0) 7737 262 913 (8am - 8pm) Monday - Saturday
Email: brunopeek@mas.com

From: Rosemary Mitchell
To: WW1Commemorations2018@york.gov.uk;
cc: alanmitchell1959@hotmail.co.uk;
Paul Deamer;
Subject: Re Plans for WW1 Commemorations
Date: 11 December 2017 22:11:18

Dear Councillors

Further to your email regarding the above, we discussed the Guild's thoughts at our Court meeting last week.

We would be interesting in participating in events and I have copied in this year's and next year's Masters to keep them informed.

The Court also suggested the attached photograph, showing a poppy tribute, maybe of interest. It has been constructed by York Guild of Building York College Silver medal winner 2017.

Kind regards

Rosemary Mitchell
Clerk, York Guild of Building

From: [Stephen Upright](mailto:Stephen.Upright)
To: WW1Commemorations2018@york.gov.uk;
Subject: RE: Plans for WW1 Commemorations in York in 2018
Date: 12 December 2017 10:16:14

Good morning,

Apologies for the delayed response to your e-mail. The Company of Merchant Adventurers has no specific plans for any WW1 Armistice Commemoration events but would be willing to participate in any city-wide events.

Regards,

Stephen Upright

Captain Stephen Upright RN
 Clerk to the Company of Merchant Adventurers
 of the City of York
 The Hall
 Fossgate
 York YO1 9XD
 01904 654818
www.merchantshallyork.org

From: WW1Commemorations2018@york.gov.uk [mailto:WW1Commemorations2018@york.gov.uk]
Sent: 21 November 2017 13:42
To: 'steve.bielby@btopenworld.com'; 'timjhinton@mypostoffice.co.uk'; 'davehobman@tiscali.co.uk'; 'thomasg624@aol.com'; 'the.clerk@theyorkcompany.co.uk'; 'clerk@merchant-tailors-york.org'; 'jean@jjsawdon.co.uk'; 'everyone@guildofmediaarts.com'
Subject: Plans for WW1 Commemorations in York in 2018

Dear Guilds,

As you will be aware, next year will see the 100 year anniversary since the end of World War I. The war saw horrifying loss and suffering and, whilst being called 'The war to end all wars', it of course proved to be far from that. Whilst all those that fought in the war have sadly now passed away and those who lived through it are now few in number, it is vital we continue to remember those that died in WW1 and those that have subsequently died in defence of our nation, and to educate people for the future. Next year's 100 year anniversary will be all the more poignant as it falls on a Sunday, although we are hoping that day will be just the culmination of a series of events across York.

Earlier this year, City of York's Council passed a motion calling for a Councillor group to be set up to co-ordinate plans for the commemoration across the city, with the aim of ensuring that as many people as possible feel part of the commemoration— see copy of motion attached.

As the members of the Councillor group, we are keen to find out about:

- Any plans that you may already be developing to commemorate the WW1 centenary;
- What the Council and its partners might be able to do to support those plans, and;
- What other ideas you might have for commemorative events or initiatives that

you think the city might pursue

- Whether you would be willing to participate in any events being organised in the city

We are writing to a range of organisations and individuals – see copy of list attached.

We would be delighted to hear your thoughts and would welcome your feedback by email or, if there is demand we could soon set up a round table meeting for all interested parties. We would also welcome your suggestions for others we could write to.

We look forward to hearing from you and would welcome your initial response by no later than Sunday 10th December 2017.

Yours sincerely

Cllr Ashley Mason
Cllr Chris Steward
Cllr Dave Taylor
Cllr Margaret Wells
 (WW1 Commemorations 2018 City of York Council Task Group)



 Help protect the environment! - please don't print this email unless you really need to.

This communication is from City of York Council.

The information contained within, and in any attachment(s), is confidential and legally privileged. It is for the exclusive use of the intended recipient(s). If you are not the intended recipient(s), please note that any form of distribution, copying or use of this communication, or the information within, is strictly prohibited and may be unlawful. Equally, you must not disclose all, or part, of its contents to any other person.

If you have received this communication in error, please return it immediately to the sender, then delete and destroy any copies of it.

City of York Council disclaims any liability for action taken in reliance on the content of this communication.

City of York Council respects your privacy. For more information on how we use your personal data, please visit <http://www.york.gov.uk/privacy>

From: Bond, Danielle
To: Carr, Melanie; Pollitt, Richard;
cc: Steel, Dawn
Subject: RE: WW1 Commemoration SCrutiny Review - Task Group's suggestions for how the Mansion House might support and be part of a programme of events leading up to Armistice Day 2018
Date: 20 December 2017 12:05:45

Hi Melanie,

Sorry for the delay on this as I know your meeting is this afternoon.

Ideas:

- Work with the archives to create an exhibition in the Mansion House re the civic party of that year, what the house was used for, images and special documents from that year
- Richard mentioned having poppies 'yarn bombed' onto the Mansion House gates (google it, it definitely looks cool!)
- Collab with local Universities and Yorkshire Air Museum to set up regular evening lectures in the Mansion House in regards to History, Art and Literature of the time (i.e. WWI poetry)
- Collab with MakeltYork to create a WWI commemorative trail through the city that takes people around York to historical sites of interest for WWI
- Create special kids trail as well to help children engage with history...
- Collab with local artists/YorkBid to create a temporary sculpture in St Helen's Square

Has anyone been in touch with MakeltYork to see if they're working on anything yet?

I hope this helps and do let me know if you need anything further!

Best wishes,
Danielle

Danielle Bond | Acting Marketing and Events Manager

t: 01904 555131 | M: 07810881639

e: danielle.bond@york.gov.uk

City of York Council | Mansion House & Civic Services / Democratic Services

Mansion House | St Helens Square | York YO1 9QL

www.mansionhouseyork.com

www.york.gov.uk

[Facebook.com/Mansion-House](https://www.facebook.com/Mansion-House)

Twitter @YorkMansionHse

From: Carr, Melanie
Sent: 18 December 2017 12:27
To: Pollitt, Richard
Cc: Bond, Danielle; Steel, Dawn
Subject: WW1 Commemoration SCrutiny Review - Task Group's suggestions for how the Mansion House might support and be part of a programme of events leading up to Armistice Day 2018

Hi Richard

I understand Dawn has spoken to you about my ongoing scrutiny review to consider the city's commemoration of the centenary of the end of the First World War.

The Scrutiny Task Group are planning to recommend that the Executive provide a budget of approx £10k to fund the procurement of an external consultant to develop and promote a programme of events (provided by others) during the period of 1 Oct – 11 No 2018, which culminates in a civic ceremonial procession, a laying of wreaths and a service in the Minster (the usual remembrance day shenanigans).

The Task Group are expecting that the majority of the £10k will be required for that procurement but have suggested that the remainder be used to support a Council contribution to the programme of events in the manner of utilising the Mansion House throughout the period of the programme to:

- To exhibit items from the WW1 period from within its historic collection:
- To display information on:
 - the civic party of the time
 - how the Mansion House was used during the war
 - the Council and the city's contribution to the war effort

I understand from Dawn that you already have some ideas for what the Mansion House may do next year to mark the centenary, so I would be pleased to hear from you what those ideas are, what you think of the Task Group's suggestions above, and how both sets of ideas could be tied together etc.

I am meeting with the Task Group on Wednesday at 4:45pm, so I would welcome your initial response asap.

Thanks

Melanie

Melanie Carr | Scrutiny Officer

t: 01904 552054 | e: melanie.carr@york.gov.uk

City of York Council | Scrutiny Services

Room F031 | 1st Floor | West Offices | York YO1 6GA

www.york.gov.uk | [facebook.com/cityofyork](https://www.facebook.com/cityofyork) | [@CityofYork](https://twitter.com/CityofYork)

<< OLE Object: Picture (Device Independent Bitmap) >>

From: [Chris Keady](#)
To: WW1Commemorations2018@york.gov.uk;
Subject: WW1 Commemorations
Date: 13 December 2017 09:15:26

Hello,

My name is Chris Keady, I am the Learning and Participation Manager at the National Railway Museum.

I was recently forwarded a request from a colleague about the upcoming 2018 WW1 Commemoration programme, and our involvement in this.

We would very much be interested in being a part of this programme, and could look at offering object handling and perhaps a talk or tour highlighting objects from the collection of particular significance.

Please may I ask if this sort of programming would be suitable? I can discuss with the curatorial team and pull together some more concrete ideas if this would work?

Many thanks,

Chris

Chris Keady
Learning & Participation Manager (Masterplan)

National Railway Museum
[Leeman Road](#)
[York YO26 4XJ](#)
chris.keady@nrm.org.uk
01904 686291
nrm.org.uk
follow us on twitter [@railwaymuseum](#)

A member of the Science Museum Group

The Science Museum Group consists of:
Science Museum, London
Museum of Science & Industry, Manchester
National Railway Museum, York and Shildon
National Media Museum, Bradford

This e-mail and attachments are intended for the named addressee only and are confidential. If you have received this e-mail in error please notify the sender immediately, delete the message from your computer system and destroy any copies. Any views expressed in this message are those of the individual sender and may not reflect the views of the Science Museum Group. Please note that any information sent, received or held by Science Museum Group may be disclosed under the Freedom of Information Act 2000.

This email has been scanned for email related threats and delivered safely by Mimecast.

From: [Brian Bell](#)
To: WW1Commemorations2018@york.gov.uk;
Subject: Fw: WW1
Date: 18 December 2017 14:09:43

Dear all

As a Parish Council we have already listed ourselves with the 'Battles Over' remembrance site. Mr Bruno Peek (pageant-master) has acknowledged our application, and an update of the programme will be communicated to us in January 2018.

We have also requested information from Bulfinch Gas Equipment (the preferred contractor in the 'Battles Over' document) if however you have a local contractor for the beacon equipment in mind, we would be willing to consider something local.

These are some of the questions we will consider as a group, after the new year

What type of ceremony do we envisage?

- Start/finish time
- Would the remembrance ceremony be similar to the traditional day time (11am) remembrance service held each year
- Involvement of other groups (Church, Scouts, Guides, RAF)
- Music, Choir, Brass Band, Reading (if so who, and does anyone want to lead the ceremony)
- Anticipated numbers (greater or fewer than previous remembrance services)
- Basic shelter (gazeebos, umbrellas?)
- Enhanced Lighting
- Street closure process
- Basic Refreshments
- Safety Wardens
- Expert advice
- Installation of equipment
- Dismantling of equipment
- Setting up site
- Closing down site
- Location of Beacon and equipment
- Storage of LGP gas cylinders
- Design and Publication of programme
- Advertisement of event

- Establish Links with CYC

We intend to hold a working group meeting of teh PC in early January 2018, to explore options

Kind regards

Brian Bell
Copmanthorpe Parish Council

The information in this email, and any attachments, are confidential and intended for the person they are addressed to. If this email was not intended for you, you may not copy, use or share the information in any way. Please email postmaster@eastriding.gov.uk to advise us that you have received this email in error. East Riding of Yorkshire Council is able to, and reserves the right to, monitor email communications passing through its network. The council does not accept service of legal documents by email. We have made every effort to virus check this email and its attachments. We cannot accept any responsibility or liability for loss or damage which may happen from opening this email or any attachment(s). We recommend that you run an antivirus program on any material you download. --

From: [Cllr. C. Steward](#)
To: WW1Commemorations2018@york.gov.uk;
Subject: FW: WW1 at Yorkshire Museum of Farming
Date: 18 December 2017 15:12:07
Attachments: [image001.png](#)
[image002.png](#)
[image003.png](#)
[image004.png](#)

From: Dan Kirk [<mailto:d.kirk@murtonpark.co.uk>]
Sent: 17 December 2017 09:35
To: Cllr. C. Steward
Subject: WW1 at Yorkshire Museum of Farming

Hi Chris,

I have sent this email to the WW1 commemoration address but I'm not sure it came through so I thought I'd send it straight to you as well. I'm the events coordinator at the Museum of Farming based in Murton. I saw the article in the press and it is something we would be interested in getting involved in. We would look more at the role animals played in the war and the farmers who were called up to serve the country. We have pencilled in Sunday September 23rd for this.

One other thing I was wondering is if there is any funding available for the commemorations? I only ask because I have been in contact with a group who do displays of WW1 cavalry but unfortunately it is out of our price range as a small independent museum. I understand if not but I thought it was worth asking.

All the best

Dan

Dan Kirk MA
Deputy Site Manager & Events Coordinator

Yorkshire Museum of Farming
Murton Lane
Murton
York
YO19 5UF
Charity No:510900

Tel: 01904489966

Website: <http://www.murtonpark.co.uk>

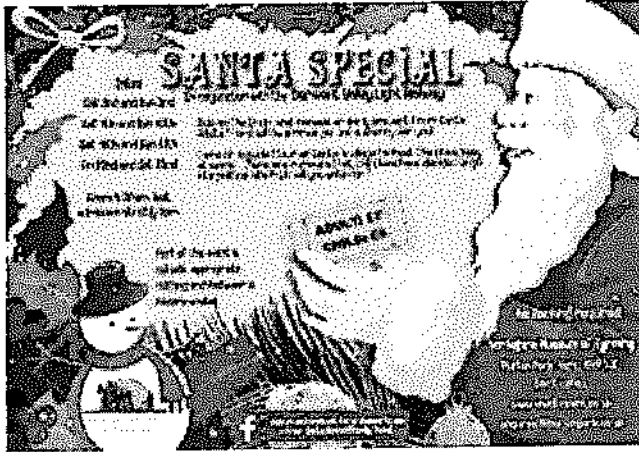

Carr, Melanie

From: Cllr. C. Steward
Sent: 19 December 2017 10:11
To: WW1Commemorations2018@york.gov.uk
Subject: FW: Great War Centenary Commemorations 2018
Attachments: JR VILLAR THEATRE YORK 2018.pdf, My Tender Trench Centenary.pdf

From: JR Villar [mailto:rei_villar@hotmail.com]
Sent: 18 December 2017 18:31
To: Cllr. C. Steward
Subject: Great War Centenary Commemorations 2018

Dear Cllr. Chris Steward

I'm writing to present a project for the Great War Centenary Commemorations in 2018. I also offer my creativity and experience to collaborate on any other projects that the CYC will organise next year for this important commemoration. My project, as well as my CV, are attached to this email. Looking forward to hearing from you.

With my best regards
João Rei Villar



JR VILLAR
EMMY® Winning Scriptwriter
Theatre, TV and Film. Creative Expertise.
York, United Kingdom
Mob: 07 841 656 804
[IMDB](#) [LinkedIn](#)

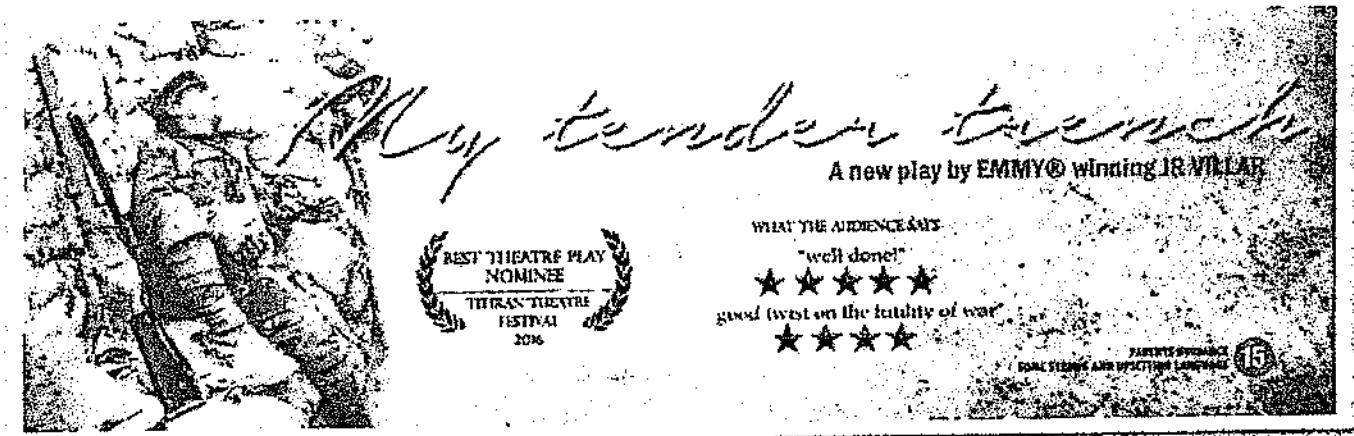

THE GREAT WAR - CENTENARY COMMEMORATIONS 2018

A soldier and a young girl get trapped in a trench. They discuss duty and what is right or wrong in a war, but when an enemy is captured by the soldier everything is going to change.

"My Tender Trench" was nominated for best play at the Tehran Theatre Festival 2016 and received wide applause from the audience. Also was recently the subject of a seminar at the University of North Iowa.

"MY TENDER TRENCH" is a high quality production written by the EMMY winning writer, JR Villar.

Considering that next year we are commemorating the Centenary of the end of the Great War, I'm intending to put into stage.

The play has minimum production needs and can be performed in open air (as a summer production, for a more realistic setting) as well as a studio performance

The original script is suitable for 15 Years and above, due to some strong language, adult subjects and some upsetting visual scenes, obviously related to the theme of the war.

The performance also has space for musical moments in scene transition. Other community groups (for example, choirs) can be incorporated in this transitions and turn it in a more diverse and inclusive event. I'm really happy to discuss with the York Council committee and other community groups, making it a beautiful eye-catching event.

SET / STAGE

The set is a very simple representation of a trench. Just some sand bags, and stylised trees (can be real ones if set on open air).

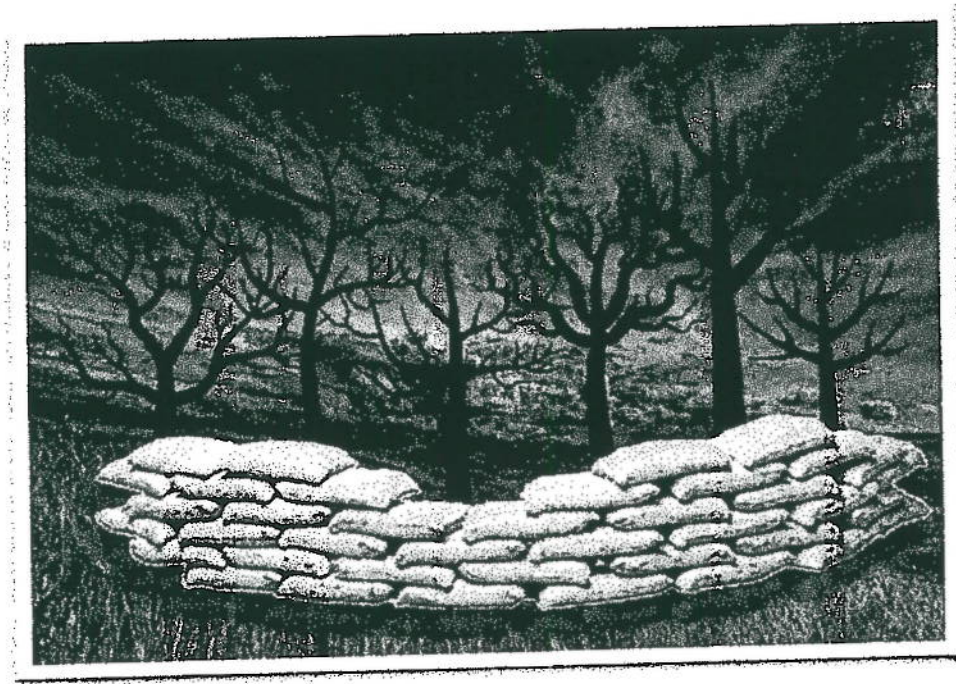

Figure 1 - Set Project

I'm happy to discuss and collaborate with other ideas that we can work together, for instance, any kind of projects that we can develop targeting schools' youngest audience.

I'm available to meet with you and talk about any ideas that you have in mind.

Looking forward to hearing from you,

With best regards

JR Villar

From: Christopher Rainger
To: WW1Commemorations2018@york.gov.uk;
Subject: FW: WW1 Commemorations in York
Date: 19 December 2017 11:24:13
Attachments: [Heslington Men Booklet - Final.pdf](#)

WW1 Commemoration in York

Further to the article in the Press, I am writing to say that Fishergate, Fulford and Heslington Local History Society will be interested in supporting these commemorations.

You may already be aware that our Society has researched the lives of the men named on WW1 Memorials in our area and we have held a number of events, including an exhibition involving other local groups and speakers at the Cemetery Chapel.

Since the start of the commemorations, we have published three booklets on the lives of the 86 men named on the memorial which stands outside St Oswald's Church in Fulford.

In November this year, we published a similar booklet on the seven men named on the Heslington Church Great War Memorial Window and we held a very moving event in front of the window, where seven people from the village read sections from the biographies, written in the first person. These were interspersed with passages describing the village these men would have known.

We have almost completed our research into the lives of the 87 former pupils of Fishergate School who are named on the memorial plaque in the entrance to the school. We will present this research in a booklet which we plan to 'launch' at an event at the school in November 2018, where we hope to

attract parents and former pupils to hear some of the men's stories and view our exhibition.

We propose to publish the Fishergate School booklet as a single volume, but because so many men are included in one volume, printing will cost approx. £20 per copy. We are therefore seeking grants to enable us to sell the booklet at an affordable price of £10.

We anticipate that printing 50 copies, so we are seeking a grant of £500.

Can the WW1 Commemoration Project help us?

Would the Project like to be involved in presentation of the research on these men?

I hope you find our work of interest and look forward to hearing from you.

I attach a copy of our Heslington booklet, to give you a flavour of how we have presented our research. Further information is available on our website: www.ffhyork.weebly.com

Best regards
Christopher Rainger
Chairman of Fishergate, Fulford and Heslington Local History Society

WW1 Commemorations 2018

The Council notes that 2018 will mark 100 years since the ceasing of the hostilities in the Great War. Whilst all those that fought in the war have sadly now passed away and those who lived through it are now few in number, it is vital we continue to remember those that died in WW1 and those that have subsequently died in defence of our nation, and to educate people for the future. The Council would therefore like to ensure that a programme of activities take place across York which will enable the residents of York to express their appreciation to all who sacrificed so much during that conflict.

The key objectives for this will be to:

- i. Fully reflect the:
 - The horrors of war, including the suffering caused by the 37 million military and civilian casualties during the First World War;
 - A diversity of perspectives on the causes and consequences of the war;
 - A commitment to learn the lessons of the past to help build peace in the future.
- ii. To commemorate the 100 year milestone

The Council is looking to develop and promote a programme of events commencing on Monday 1st October 2018 and culminating on Sunday 11 November 2018.

The event organiser will be required to:

- Develop a programme in consultation with partner organisations, faith groups and other interested parties
- Liaise with businesses and other civil society organisations in York to ensure contribution to the programme
- Liaise with Council departments as appropriate to develop the programme
- Provide event management for any directly delivered components of the programme including risk assessment, liaison with the Safety Advisory Group, etc.

Elements of the programme that would be expected:

A military contribution: This would include but not limited to a military parade with tri-service representation as part of the Remembrance Sunday Procession.

A business contribution: Activities and one off events from a range of organisations that demonstrate appreciation of those who sacrificed so much during that conflict and its effect on the city and its residents.

A council contribution: A special exhibition /event in the Mansion House throughout the period.

A civic contribution: This would include but not limited to the Remembrance Sunday Procession, laying of wreaths and attendance at the Remembrance Service at York Minster on 11 November 2018.

The Council's maximum budget for the development and promotion of a programme of events is £10k

Interested parties are asked to submit proposals by 28 February 2018 setting out:

- Their initial proposals for the programme (accepting that this will develop through consultation and engagement with partner organisations)
- A budget breakdown indicating days required and the charge per day
- A statement concerning relevant experience with specific reference to relevant experience of the armed forces community

Meeting Dates	Children, Education & Communities Policy & Scrutiny Committee Draft Work Plan 2017-18
Tues 27 June 2017 @ 5:30pm	<ol style="list-style-type: none"> 1. York Museums Trust – Partnership Delivery Plan Bi-annual Update (Reyahn King) 2. TdF Scrutiny Review Draft Final Report 3. Draft Workplan & Discussion re potential scrutiny topics for 2017/18 <p>Meeting cancelled - All business deferred to July 2017 meeting</p>
Wed 5 July 2017 @ 5:30pm	<ol style="list-style-type: none"> 1. York Museums Trust – Partnership Delivery Plan Bi-annual Update (Reyahn King & Michael Woodward) 2. Attendance of Executive Members – Priorities & Challenges for 2017/18 <ul style="list-style-type: none"> • Executive Member for Culture, Leisure & Tourism - Cllr Ayre (confirmed) • Executive Member for Education, Children & Young People – Cllr Rawlings (confirmed) • Deputy Leader, Community Engagement – Cllr Aspden 3. Year End Finance & Performance Monitoring Report (Richard Hartle) 4. TdF Scrutiny Review Draft Final Report 6. Draft Workplan & Discussion re potential scrutiny topics for 2017/18
Wed 19 Sept 2017 @ 5:30pm	<ol style="list-style-type: none"> 1. First Quarter Finance & Performance Monitoring Report (Richard Hartle) 2. Update on York Trial of 30 Hours Free Childcare for Working Families (Barbara Mands/Nicola Sawyer) 3. CYC Bi-annual progress report on Safeguarding & Looked After Children (Eoin Rush) 4. Learning Services Year End Update (Alistair Gourlay) 5. Presentation on the Vision for the City’s Library Service (Charlie Croft) 6. Implementation Update on Previously Completed Ward Funding & Play Scrutiny Reviews (Mary Bailey) 7. Workplan 2017/18
Wed 14 Nov 2017 @ 5:30pm	<ol style="list-style-type: none"> 1. Explore York Libraries & Archives Mutual Ltd SLA Bi-Annual Update (Fiona Williams) 2. Make it York Bi-annual Update with attendance of Managing Director (Steve Brown) 3. Update On Early Help Strategy, Local Area Teams & 30 Clarence Street (Niall McVicar) 4. School Improvement and Ofsted Update on Schools Performance (Maxine Squire) 5. Update on Academisation, Place Planning & Additional School Places Required (Maxine Squire) 6. Update on York Museum Trust Custodianship Arrangements (Charlie Croft) 7. Workplan 2017/18

<p>Wed 10 January 2018 @ 5:30pm</p>	<ol style="list-style-type: none"> 1. York Museums Trust – Partnership Delivery Plan Bi-annual Update (Reyahn King) 2. Second Quarter Finance & Performance Monitoring Report (Richard Hartle) 3. CYC Bi-annual progress report on Safeguarding & Looked After Children (Eoin Rush) - deferred 4. WW1 Commemorations Scrutiny Review Draft Final Report 5. Workplan 2017/18
<p>Wed 21 March 2018 @ 5.30pm</p>	<ol style="list-style-type: none"> 1. Attendance of Chair of York@Large (Chris Bailey) 2. Third Quarter Finance & Performance Monitoring Report (Richard Hartle) 3. York Safeguarding Board Bi-annual Update (Will Boardman) 4. SACRE (Standing Advisory Committee on RE) Annual Report & Review of York Schools' Agreed Syllabus (Mike Jory & Shabana Jabbar-Chair of SACRE) 5. Learning Services Biannual Update & Draft Self-Assessment Report (Alistair Gourlay) 6. Workplan 2017/18
<p>Wed 16 May 2018 @ 5:30pm</p>	<ol style="list-style-type: none"> 1. Attendance of Chair of Learning City (Alison Birkenshaw) 2. York Theatre Royal Bi-annual Performance Update (Liz Wilson) 3. Explore York Libraries & Archives Mutual Ltd SLA Bi-Annual Update (Fiona Williams) 4. Learning Services Bi-annual Performance Update (Alistair Gourlay) 5. Update on School Meals Take-up (Mark Ellis) 6. Make it York Annual Report 7. Draft Workplan for 2018/19

Possible areas for review:

School Attendance – Behavioural Attendance Partnership / Penalty Notices etc